

More Fun with Langford's Problem!

by John E Miller
Portland, Oregon, USA

Abstract

The known number of solutions to the classic problem has been extended through $n=28$; Similar progress was made on Knuth-planar solutions; An End Run variation of planar solutions has been defined and explored; A subset of solutions of the classic problem conform to a Colombian Variant; Tanton's Chairs - A puzzle based on a circle of chairs was explored as a variant of LP; Langford Quilts. We provide exercises and a link to the Langford's Problem web page.

Introduction

Consider these pairs of colored blocks. There's one block between the red blocks, and so on.

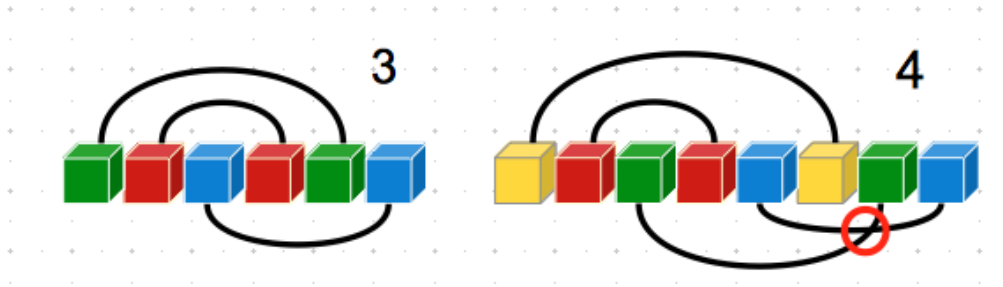

If you try do this with five or six pairs, you won't succeed. It's not hard to prove that you can fit blocks together in this way only when the number of pairs is a multiple of four, or one less.

There are 26 unique ways 7 pairs of blocks can be arranged; 150 solutions with 8 pairs.

At G4G11 (2014), I reported that Langford's Problem had been enumerated up to 24 pairs of blocks.

In July 2015, Team Assarpour-Liu, extended the known number of solutions

27 ==>	111,683,611,098,764,903,232	(111 Quintillion)
28 ==>	1,607,383,260,609,382,393,152	(1.6 Sextillion)

No solutions are possible for 29 & 30 pairs. Counts for 31 & 32 pairs are unknown.

There is no combinatoric formula for the number of solutions. However, Dr Zan Pan recently developed an asymptotic formula estimating the number of Langford and the Skolem sequences! See the website for a link to Dr Pan's paper.

Planar Solutions

What is a Knuth-Planar solution? Pairs can be connected by lines in the plane, *without crossing*. By definition, it's 'no fair' going around the end of the arrangement to avoid crossing. Three pairs are naturally planar.

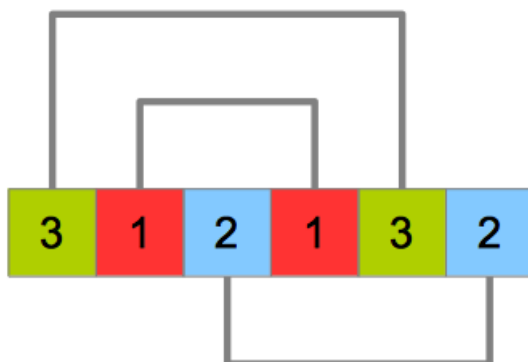

In the Introduction above, four pairs are not Knuth-planar. (See red circle around the crossing.) Think of connections only allowed in the white areas above and below the arrangement in this diagram of a planar solution for 8 pairs:

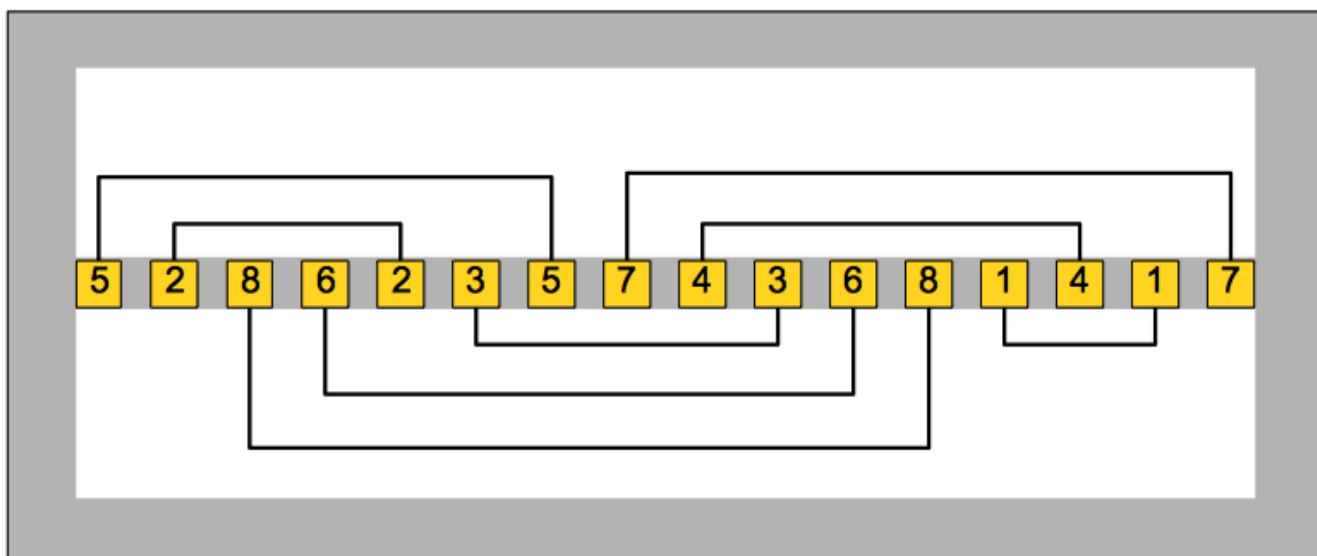

Knuth solved for Planar Solutions up to $n=28$ in 2007. In January, 2018, Rory Molinari confirmed Knuth's previous results, and obtained these results

$$P(2,31) = 5,724,640$$

$$P(2,32) = 10,838,471$$

Computer programs were able to enumerate because the search space is radically reduced.

A Colombian Variant

This variant of Langford's Problem was cooked up in Colombia by Freddy and Bernardo in 2019.

A sentinel pair restricts all smaller pairs from being completely inside the sentinels.

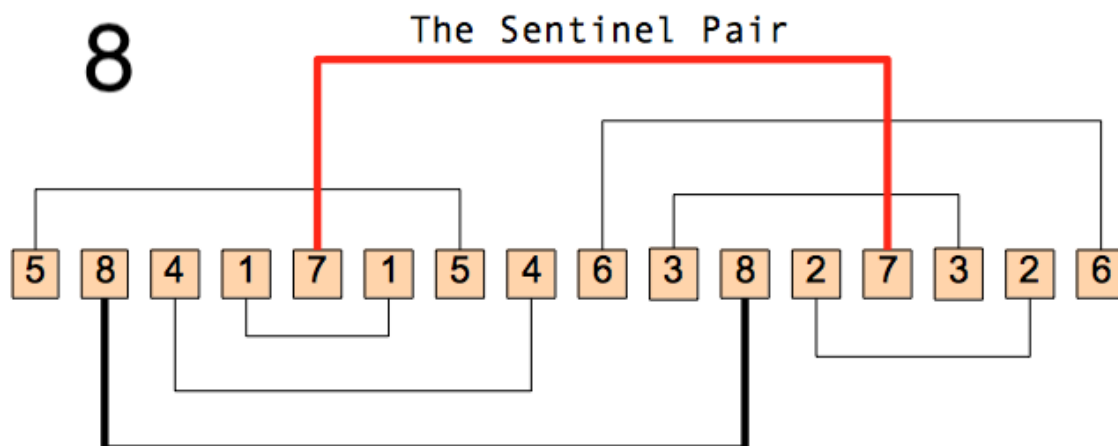

Consider the above arrangement for 8. Put the 8's in an empty array, and then put the 7's in such that they partition the arrangement into left and right. Here we see 4 empty spots to the left and 3 on the right. The 8 takes one of the spaces on the left. The Colombian Variant constrains the remaining pairs to have one leg between the sentinel pair and its other leg outside, as we see the green and blue subsets in the Colombian Variant below for 11 pairs.

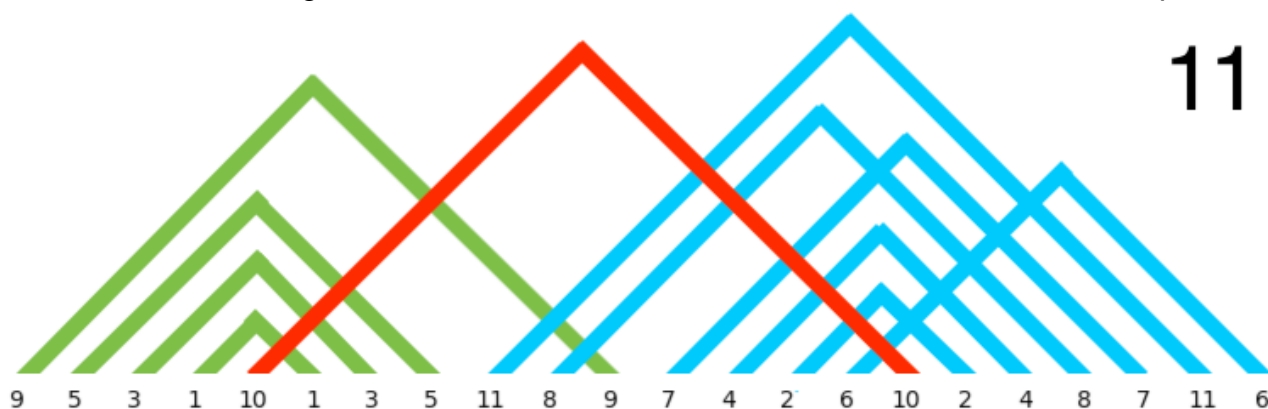

Colombian Enumeration Very few solutions of LP conform to CV constraint.

Colombian Variant connects to the Davies construction method (1958), i.e., the singular Davies Construction results in a Colombian Variant solution.

The Colombian Variant has a dedicated page on the Langford's Problem set of web pages.

Summary of Numbers of various solutions

End Run Planar includes more solutions than Knuth-Planar, because you have the Knuth planar plus end run planar solutions.

	CLASSIC	PLANAR	END RUN	COLUMBIAN
3	1	1	1	1
4	1	0	1	1
7	26	0	6	3
8	150	4	24	10
11	17792	16	139	76
12	108144	40	289	140
15	39809640	194	2414	2478
16	326721800	274	4455	5454

There is a large Table of Solutions to be found on the Langford's Problem set of web pages.

Tanton's Chairs (A circular version of LP)

10 students sit in a circle. Is it possible for one student to move 1 place clockwise, one student 2 places clockwise, one student 3 places clockwise, and so on, all the way up to tenth student moving 10 places clockwise (back to his/her own seat) and ALSO end up one student per seat? 11 students?

To solve this, you must match up unique "future chairs" for the students with the constraint of also moving unique number of chair "units". Each student is destined to move a unique number of chairs clockwise, to (hopefully) claim an empty chair.

I recognized that Tanton's present-and-future chairs are like Langford's pairs of colored blocks. So I hacked my "standard algorithm" for Langford's Problem to use a wrap-around array and counted solutions for 1..15 students/chairs. The solution sequence seems to be: 0, 0, 1, 0, 3, 0, 19, 0, 225, 0, 3441, 0, 79259, 0, 2424195, ... (Only odd numbers of seats work, so there are 0's in the sequence.) Tanton's question about 11 chairs has 3,441 solutions!

Due to the Circular nature, without loss of generality, we only need to examine solutions with the first student starting in a particular chair. (Otherwise, we'd duplicate solutions.)

Two sample solutions for n=11. Figures below show sample solutions for n=11, using straight arcs, rather than lines curving around the circle of chairs.. A short line that looks like it might be going counter-clockwise is just taking a direct path. Green denotes a Start chair; Reds are Stop chairs.

One figure shows two non-trivial cycles. The other figure shows a solution for 11 chairs, consisting of five pairs of students swapping chairs, and one staying put (the one looper).

There may be a better representation of Tanton's Chairs using circular arcs. Feel free to play!

Cliques. I wondered whether the chair swapping would be one long chain - a student takes a chair, the student who was in that chair takes different chair, and so on. (plus the one $n \rightarrow n$ looper). BUT! I noticed 'cliques' in some of the solution sequences. A clique is a distinct subset of chairs involved in the swapping.

Most solutions are not one long cycle, but contain two or more cliques. See a complete analysis on the website.

The black & white figure has two 4-cycles, three 2-cycles, and 1 loop. ($8+6+1=15$)

This turns out to be sequence A003111 on [OEIS], Number of complete mappings of the cyclic group Z_{2n+1} . Thanks to Ian Duff, UK, for pointing this out!

Figures

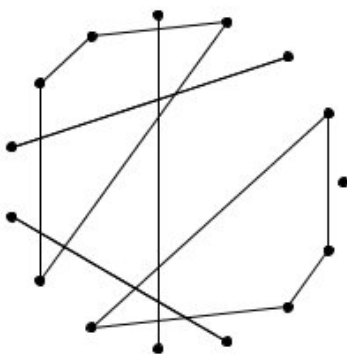
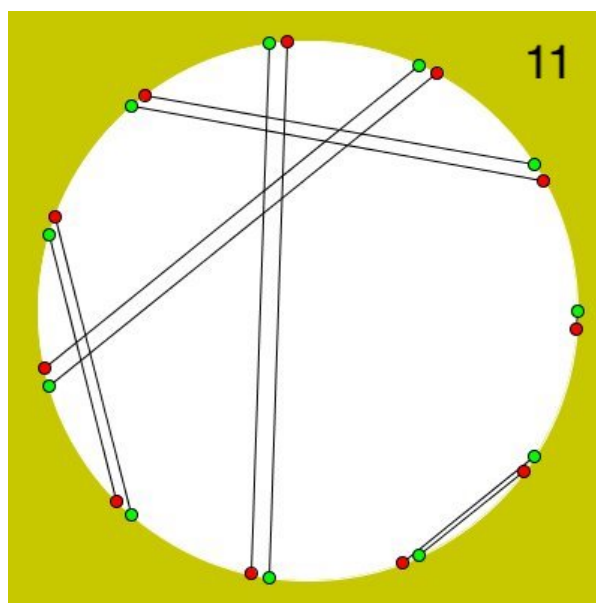
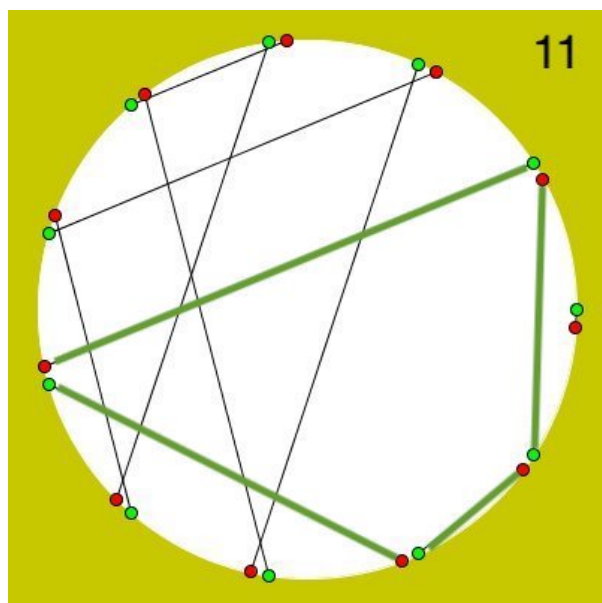

Langford Quilts

A Langford Quilt results when we place solutions together with no space between rows, and use black to separate the columns. This allows the colors to run together serendipitously between rows. This nearly square quilt is made using the 26 solutions for 7 pairs. The quilt has 26 rows, $14+13=27$ columns, and a black border.

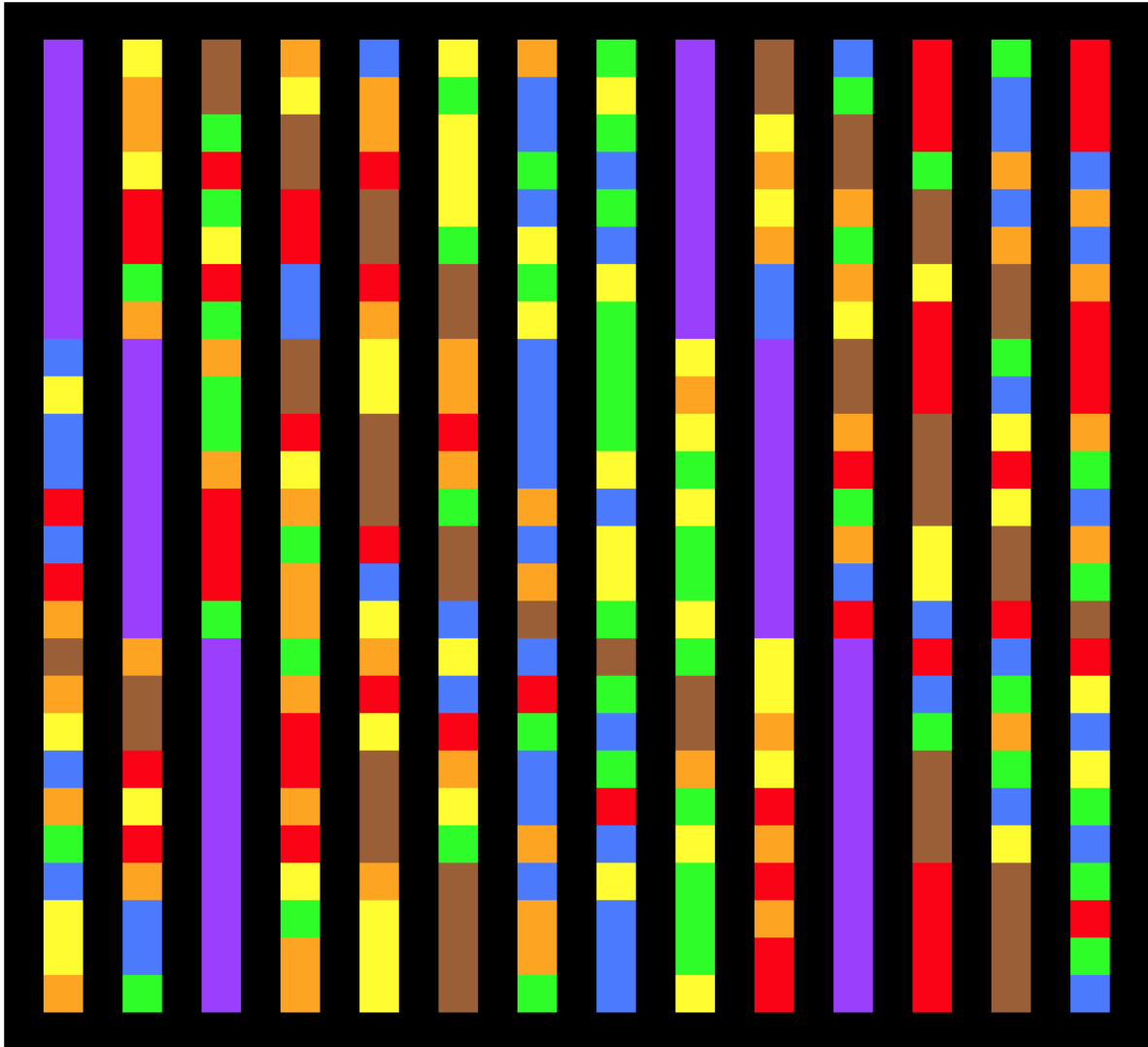

Exercises

1. Planar connections between pairs in this solution: [4 5 6 7 8 4 1 5 1 6 3 7 2 8 3 2] require five looping joins. Can you find them?
2. How many Colombian Variants are Planar, or End Run Planar? Any? All? Discuss.
3. Prove that Tanton's Chairs can only involve an even number of chairs and students.

References

See <http://dialectrix.com/langford.html> for all references.