

# CROWBAR

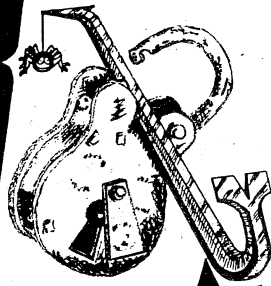

SQUATTING NEWS No 47



BM Box Hurricane London WC1

25P

## UPRISING 86

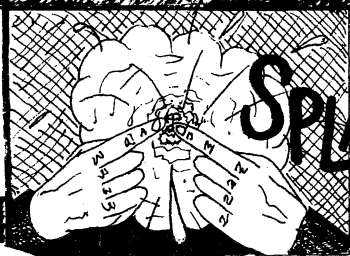

REMEMBER  
YOU SAW IT BURST  
IN  
CROWBAR



HOW LONG  
MUST WE BE  
BEATEN, KICKED, CHOKED,  
MUTILATED, RAPED AND KILLED?

Stop  
African  
Business  
South

On June 16th (Soweto day) a group of about 25 comrades occupied five South African connected banks in the City Centre. We started with the shopping centre Barclays, went on to the city branch which we managed to close down for ½ an hour. The employees (50 or so) were quickly told to leave by the management and the doors locked. Passers-by were informed by a notice that this was in commemoration of the massacre at Soweto. Other banks occupied were Barclays (International), Standard Chartered and the Clifton Barclays - in this one phone calls were answered on behalf of those comrades murdered by the South African police! - As usual there was a press blackout.

The Bristol Young Comrades

# COMRADES

At least 18 prisons were hit by rioting which erupted during the night and left a trail of destruction. One prison was mostly destroyed by fire.

CROWBAR

No.47

A new squat 'centre' has been opened in the former buildings of the City Limits magazine, 313 Upper Street, N London. A caf, gigs, meetings benefits and more now take place there.

SQUAT!!!

SQUAT

SQUAT!!!

SQUAT

MURDOCH IS BAD NEWS  
DON'T BUY THE NEWS OF THE SUN THE TIMES SUNDAY TIMES  
SOGAT·NGA·AUEW·NUU

ALL LONDON SQUATS

As my friend has just told me the last 'Crowbar' came out 'ages ago', so... we can deduce that since then, there have been many All London Squatters Meetings!

The last one was at the recently squatted City Limits building at 313 Upper st, Islington. As usual each squatting group said their piece, the only trouble is... almost always the same people turn up and the same things are said. In the last 3-4 months only two interesting things have happened, the squatting of the Libyan Embassy and the tragic eviction of Pullens. Incidentally, the squatters at Pullens deserve a fucking good round of applause for showing the pigs what we're all made of. WELL DONE!!

A YEAR OF OUR LIVES



HATFIELD MAIN

A colliery community in the great coal strike of 1984/85



Hooligan Press \$3.50



OO's Cafe

Sat 5-8

and also OO's Disco

occasionally

All at 121 Railton Rd Brixton SW2

we are trying to start a magazine - interested ♀ come to cafe!

TEL. 274 6655 AFTERNOONS TO CHECK BEFORE COMING.

PAGE 2

Use Ourselves

Price is £2.40 + 60p. P&P. All cheques and postal orders can be made payable to 'Suspect'. If you want to send cash then that's up to you, obviously we'll not rip anyone off, but copies of 'Ideal Home' will only be sent on receipt of money. It's not our fault if cash gets lost in the post.



GIVE AWAY PRICE

\$2.40

THE FRE



By M. Gilliland. Published by Hooligan Press

Published May 1st, 1986. Cost: £1.80

Don't miss this book. Its a rare, exciting and interesting read. Just out and published in a limited edition. In the line of The Dispossessed, its an adventure of people growing up in a time of economic collapse and violent revolutionary change...Its a book with striking images, of hilarity, sadness, beauty, freedom and horror. Its a subversive political attack, set in a too real and convincing world...Don't lose the page!

This we hope is the first of many novels from Hooligan Press, a non profit making group.

Available from: Hooligan Press. BM Hurricane, WC1. Also from: BM Bookserve, Lon. WC1 (Library Book service). Bulk Orders: A Distribution Whitechapel High St, Lon.E1.



Hooligan Press IDEAL HOME

Survival Edition

Surviving in Britain in the modern day isn't easy if you reject the State, or if the State rejects you. Even when it comes to the basic necessities of life—such as housing.....if you don't conform to the States accepted 'norm' you might have to go without. And plenty of people right now would be without a home if it wasn't for them opting for radical solutions.

This book is put together to show others exactly what alternative housing options are to be had.

# TERRY DEAN FOR HIGH JUMP

Terry Dean, a former squatter in Brixton is still in prison, facing about 30 serious charges, including burning down Tulse Hill Post Office and a furniture shop in Coldharbour Lane during the last Brixton Uprising. He has just completed his second hunger strike, which he began on June 16th (Soweto Day) and ended on July 27th, physically, he is now in a very bad way, with kidney and liver problems.

Terry left home at 12, at 14 he got 6 months detention, followed by 2 years youth prison and 2 years prison. He came to Brixton about '83 then ended up in prison, then mental prison. On his release in '88 he returned to Brixton, where he was a well-known local character.

He used to give his entire dole check to Oxfam and tried to start a charity to help people in Africa. He also used to open up squats for people, and even opened a free-food kitchen for a while in a local squat.

I'm not saying Terry Dean is a Saint. He has been accused of anti-social behaviour in the past. When the riots broke and the cops were run out Terry acted pretty crazy, but he did NOT burn the Post Office (all there agree that a small fire began in the looting & only a 1/2 hour later did it go up). They accuse him also of burning the Furniture shop, but that happened a mile away at the SAME TIME. Terry's squat was one of those raided weeks later, nothing found, he not home.

## CURRENT LOCAL SQUATTING GROUPS

These squatting groups are about self-help and exchanging information. They cannot exist without support and give-and-take. They are not alternative estate agents, and always need help keeping their empty property lists up to date. Your information can be invaluable to a homeless person!

### London Squats Guide

**BRIXTON SQUATTERS AID:** 121 Raiton Road SE24  
Sundays 3-5pm  
☎ Brixton 01 274 6655

**SQUATTERS NETWORK OF WALTHAM:** 362 Old Kent Rd  
Mondays 6-9pm  
☎ Elephant  
01 701 5804

**ADVISORY SERVICE FOR SQUATTERS:** 2 St Paul's Rd  
London N1  
Practical and legal advice for England and Wales  
Open 2-6 Monday to Friday TEL: 359 8814.

**STOKE NEWINGTON:** Stoke Newington Community Housing Action Centre  
61 Leswin Road N16  
Mondays 6-9pm

**LEWISHAM SQUATTERS:** 171 Deptford High Street  
SE8 Sats 10-11pm  
☎ New Cross

**HARINGEY HOMES FOR ALL:** 628 High Road N17  
Fridays 7.30 pm  
☎ Seven Sisters

When they got him he was ready to admit to anything they said, he later retracted. He tried to escape, did 2 long hunger strikes and declares his INNOCENCE.

PLEASE WRITE: YOU CAN VISIT DAILY.  
TERRY DEAN, B77879, Brixton Prison  
Jebb Ave, Lons SW2.

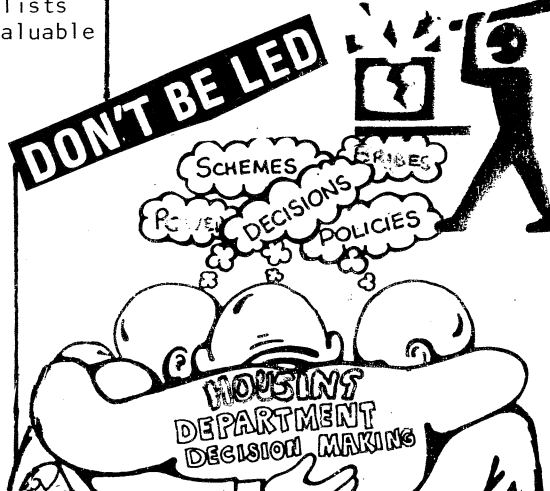

## 8TH EDITION SQUATTERS' HANDBOOK

The 8th Edition of the Squatters' Handbook is finally published and available.

On behalf of Advisory Service for Squatters who wrote and compiled it, I am sorry it's so long overdue - still it's worth the wait. It has more pages than the 7th Edition and contains a vast amount of info which is invaluable to the squatter or people thinking of squatting. Unfortunately, the amount of pictures has had to be reduced to accommodate more necessary information. The price has been pegged at 50p and we've also managed to print 1500 free copies which are going to the squatters groups in London and elsewhere. It is hoped that the Handbook will reach far and wide at a time when homelessness is increasing and conditions get more desperate. By post, the total cost for one is 67p - for larger amounts, order them and we will send you an invoice with the book from:

Advisory Service for Squatters  
2 St. Pauls Road  
London N1.





**SAVE OUR CRECHE**

The 'squatter's creche' in Brixton now overdue for a high court eviction, is still going strong. The eviction has been delayed 'for political reasons' after 25 mothers and supporters invaded the last Lambeth Housing Meeting. If it goes ahead this will be the 4th time in less than 2 years, and will be a direct decision by Linda Bellos, the new Labour Party leader, to continue the vindictive campaign of Ted Knight.

**ABOUT THE PLAYGROUP ITSELF.....**

We are open on Monday and Wednesday. The average day: at about eleven the first kids are being dropped off by their mums. By one the group is usually 5-8 toddlers, the youngest is 16 months old. Older children sometimes come along too, to play with the small ones and lend a hand. Three to four adults look after them.

After that more playing, drawing, painting, dough-fighting - I mean sculpting - messing about, reading stories. The smallest ones are by then pretty tired and fall asleep although there's not really enough facilities for that. The mothers start to come back to pick up the kids. By 6 they've all gone

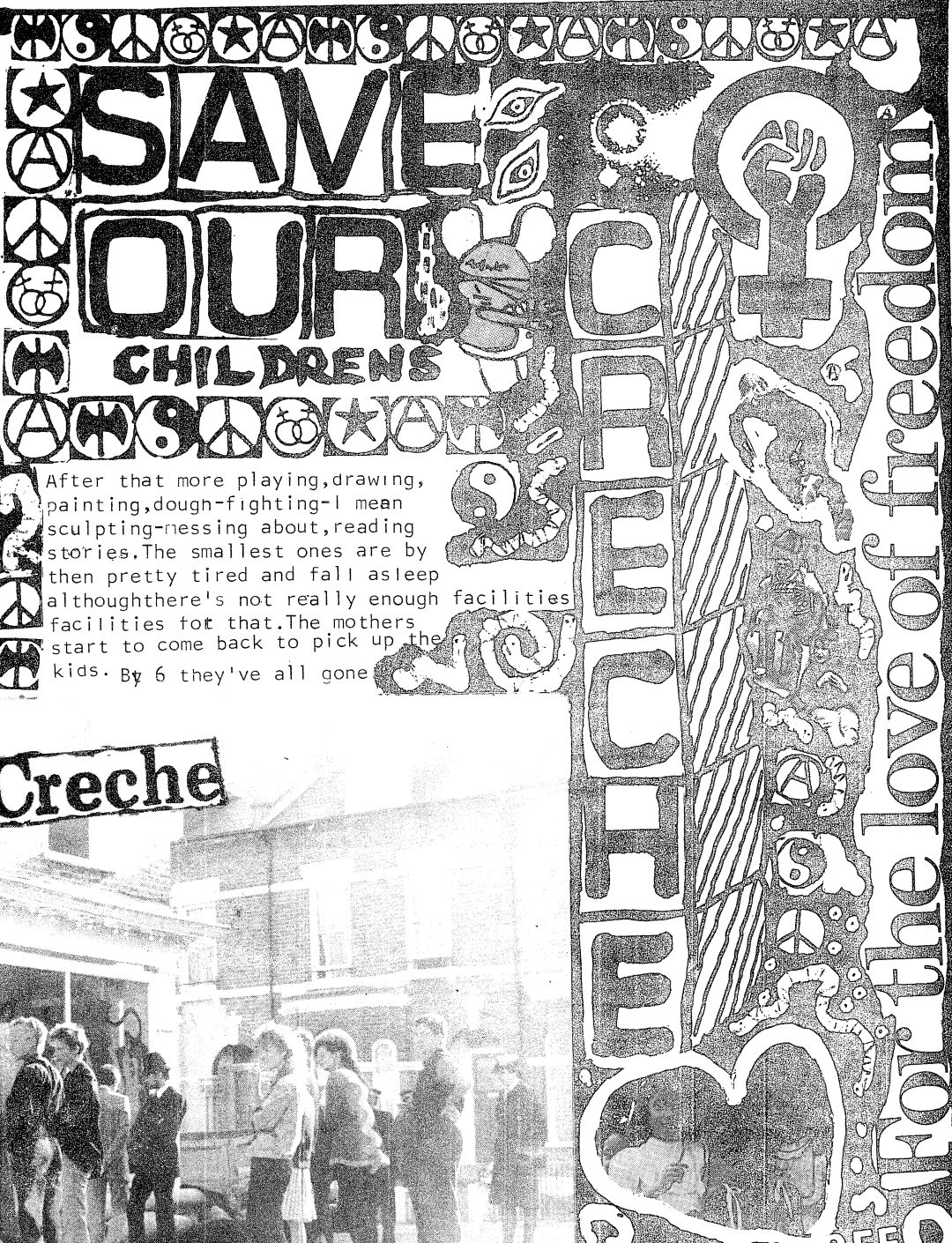

**CROWBAR**

No. 47

**Save Our Creche**

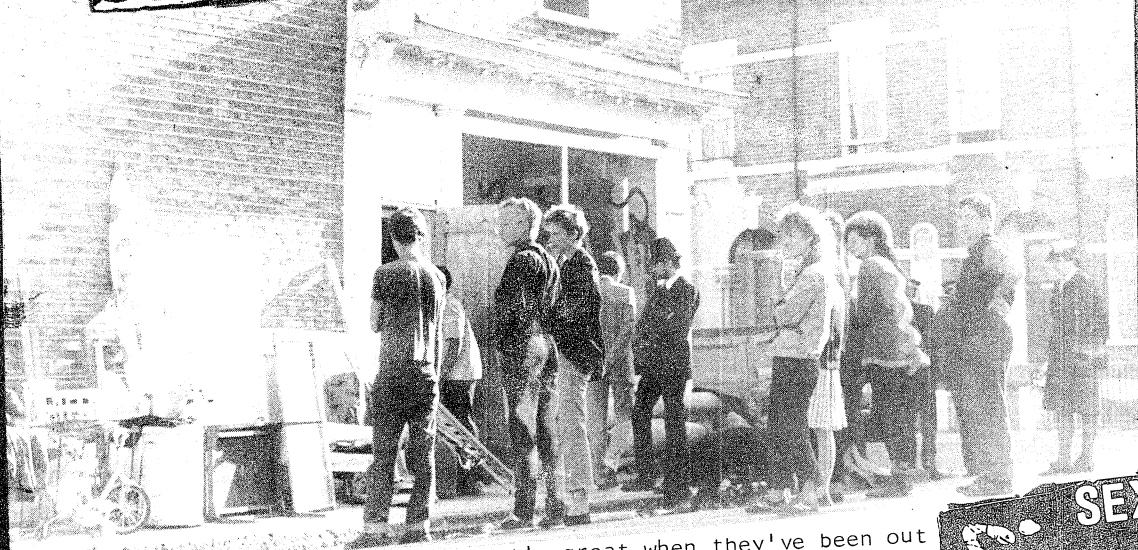

**ONE CRECHE WORKER:**

Only started looking after kids a year and a half ago, and it's great fun getting to know them, and seeing them and getting on together. It can be totally knacker though, keeping your eyes open all the time to see if they're doing something stupid. It does 'em a lot of good, not to be with their mothers - non-stop. They all used to want your attention all the time, but now most of the time they seem quite happy playing together without interference from us. It usually starts with playing inside, and if the weather allows it, in the park/playground. At usually four o'clock most of the kids start to get hungry (whinge, moan) and a meal is prepared, usually their favourite meal which is mashed spuds with baked beans, or simply toast, afterwards fruit.

It's great when they've been out running wild for a few hours, and fall asleep on their way home. The space is still a bit small I think, on a rainy day, with all the prams and that, we could make improvements, but it's a bit demoralising when the future of this place is always so uncertain. When I was small I always had my sisters, brothers cousins neighbours, there seemed to be loads of us, roughly the same age, it was a good laugh. Here I've seen some kids getting really isolated and bored and their mums too, inside the house. The group is strong and we'll go on somewhere else if the council gets stroppy again. I'd like to see lots more mothers and kids getting involved, so that in the end we'll be functioning every day. Come along and have a look - you're welcome.

**SEXISTS WANK OFF.**  
DONATIONS, TOYS, KIDS, IDEAS  
TO 77 BRAILSFORD ROAD BRIXTON  
SW2.....

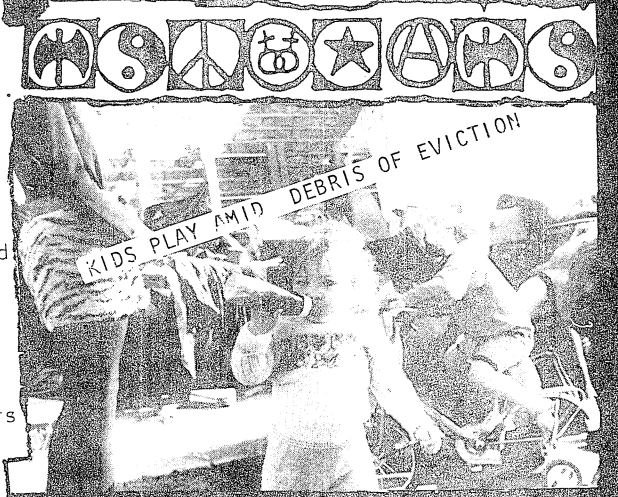



# Brighton ZAP sales

**BRIGHTON ARMS CONFERENCE**  
 In the weekend of the 28th of June a secret arms conference took place in Brighton. On sale were the latest designs and inventions for microwave technology. Microwave technology is already in use at Greenham army base where the low level microwaves are directed at the protestors. The long term effects of these waves are hardly known but on short term it causes nausea, weakness, tiredness, irregular and painful menstruation headaches etc. The effects are compared to those of microwave cookers, radio- and radar signals. The English government deny using this technology, but some of the other conference goers were less embarrassed about it. Countries that sent along sales men, included Iran and Chili. Some even told the demonstrators how proud they were to buy the new technology for their country. It is not clear what the microwaves are going to be used for; probably in warfare, but also for internal problems they might be used for crowd control etc. Some Greenham women who are investigating and gathering information about microwaves ('getting zapped') have been threatened in their own home. The official media completely ignored the conference, and the authorities are not giving any comment.

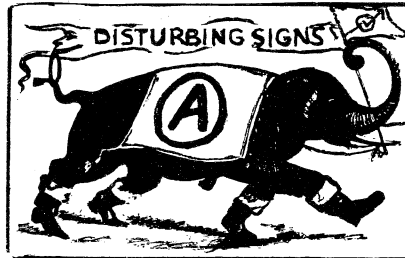

**CROWBAR**  
No.47



**"SHINE ON JIM"**  
 Video of Film about 'Punk Poet'  
**Jimmy Heather-Hayes, who firebombed**  
**Teddington Police Station, and died by**  
**hanging in Ashford Remand Centre**  
**at the time of the Falklands War.**  
 By Phil Stebbings.  
**AVAILABLE FROM**  
**121 RAILTON ROAD. LON SE24.**



# SQUAT GOSSIP

Wanna buy a squat ? Only £50! Guaranteed for a year! Positively no protected intending occupier due to move in! Plus all services in perfect working order - only £50! These are the sort of empty promises made by bastards willing to exploit homeless people - it's been happening in Camden (hello Andy Cosmos - are you receiving ?) and Stockwell Park Estate. Let's hope it ceases.

It's now inevitable that limited legislation will be introduced before parliament to criminalize certain forms of trespass. It's been reported in some papers that trespass by mass convoys of (hippy) travellers on private (and public ?) land will be made illegal. It'll be interesting to see if the bill goes any further.

News from Brighton is that squatters occupying a privately owned hotel on the sea front, were in the throes of being physically evicted when the very rich owner offered them £300 to make a peaceful exit. The situation appears even stranger as the owner's thugs had already managed to gain entry and change the lock on the front door! It was after these actions that the owner offered the dough, which was readily accepted. Sounds like Amsterdam! I wish I'd been at the party that night.

Warehouse parties are fast becoming a thing of the past in trendy Camden. Successive police raids and booze confiscation has meant that the alternative capitalists are losing thousands of mega-bucks. (What a shame). One of the fine young capitalists even ventured to ask someone from Advisory Service for Squatters to attend one of these jolifications and desuade the pigs from illegally evicting them! Some hope!

In Lambeth's Tulse Hill Estate, it's been rumoured that the resident squatters are going to get organised in time for the next eviction blitz. A couple of active people have been squatting there for a few weeks and think it's time to get organised.

Intimidation and evictions by caretakers (?) and thugs has been reaching fever pitch in one or two estates in Tower Hamlets. Squatters have been routinely evicted while out and people threatened with eviction while they're in! Surely some councillors can be spiked in the bum about these atrocities!

## Well Is It Or Aint It ?

The latest Council conspiracy to keep empty property empty, is to pay money to outgoing tenants to leave up nets and curtains in their old homes. In Southwark, obliging tenants can expect £50 reward to cover the cost of the curtains. In Lambeth, the council are too mean to cough up £50, but merely have a policy of requesting the departing tenants to leave them up. This practice may not be confined to these boroughs alone, which means there's a lot more empty property than meets the eye.

## Bristol Squats Free

PALACES AVAILABLE NOW IN SUNNY BRISTOL

Contact: Bristol Housing Action Movement,  
 156, Lower Cheltenham Place,  
 Montpelier, BRISTOL.

Meetings Mondays, 8p.m.

**WANTED**  
**ANDY**  
**COSMOS**  
 171, PRINCE OF WALES RD NW  
 MAKING MONEY OUT OF  
 HOMELESSNESS  
 SHITTING ON OTHER  
 FUCKING PEOPLE AROUND  
 TO BE MAIMED BY  
 THE PEOPLES ARMY  
 WHEN & WHERE POSSIBLE





WARM CONGRATS TO ALL THE OVER 1000 WHO WENT FOR STONEHENGE, AND HAD A GREAT TIME. DESPITE CONSTANT HARRASSMENT, SPELLS IN JAIL AND LOSS OF VEHICLES. AND A WARM 'FUCK OFF' TO THE 100,000 WHO PAYED TO GO TO GLASTONBURY INSTEAD!

STONEHENGE 86 WE WENT FOR IT



In 1985 the authorities stopped the people's free Festival with brute force...one way of saying "Hey look we're a bunch of fascists", when we're supposed to live in a nice cosy democracy. They saw the bad press it gave them, hence the 'nice' police behaviour this year.

The Stonehenge 86 campaign began in Sept 85. English Heritage invited people into holding a Stonehenge 86 to meet with them. They said we could have a one day solstice ritual dance on a "ROTA BASIS", tickets only, obtainable by writing to them. We told them they were mad and it wouldn't work, what we wanted was a site near the stones to hold a festival on. They approached the MOD (army) for us and it was decided at the highest level to say NO. Eng. Heritage then said the festival wasn't feasible and banned it again. They got Injunctions against 49 named people and got landowners, farmers and MOD to ban us from any land within a 4 mile radius of Stonehenge.

The campaign got itself organised, we held benefits, a mail order range of T shirts, posters and books was arranged. We held monthly meetings in N. London attended by people from all over England. We managed to do a newsletter after each meeting detailing what we were doing. Around the start of June 'Festival Eye' came out, giving details of this years festival and last years events.

When June came around we were prepared and ready to go. A group of about 30 walkers left Jubilee Gdns on June 1st, to get to Salisbury on the 14th. They set off in high spirits, not really knowing if they'd make it or what lay ahead.

I caught up with the walk a week later at the old Roman town Callera near Reading. This was a happy, well organised bunch, we lived together, sharing whatever we had, there was communal food for all, and a van to carry the bags while everyone walked to the next site. About 30 stayed with the walk, with others coming and going, for giroz signing on, etc.

On Thurs June 12th we arrived at Figsbury ring, just 4 miles outside Salisbury. By Fri. night we had nearly 200 of us, we all sat round the fire, having just made a massive communal meal, smoking chillums and discussing the next days carnival through Salisbury.

We set off on a beautiful Sat. morning, not knowing if anyone would join us or what. The cops had said we wouldn't be allowed into Salisbury centre, they were very freaked out by the rumour of a 'Naked Protest'! We were herded down a ring road, to be greeted by the wonderful sight of 100's of people coming towards us! We all joined up and marched along. Every time I looked around more and more people were joining ..Cars, ambulances, trucks and motorbikes appeared from nowhere and joined in. People waved from their houses, the sun shone. We felt great. By the time we got out of Salisbury we had 60 vehicles, about 50 motorbikes and 1000 odd walkers. We reached our site for the evening at Gravely Woods at about 8.00pm, still all together, except for one woman who was injured on the way. We sat up late, got stoned and relaxed.

The next day we decided to move, the druids and some locals had sussed out a site for us, but when we had a site meeting to discuss it, someone blabbed out our destination. As we lined up the police chopper flapped above us, announcing through its loud-hailer that we must not go to Yarnbury Castle.

So off we went, hooray, the convoy's on the move again! This time we were much better organised, we had a CB up the front, one in the middle, and one at the back, and me on my motorbike running up and down, making sure there were no breakdowns, stoppages etc. The front vehicle had sussed another site. As we neared it the pigs blocked every side road and the gate. There were loads of them in the field we wanted to go in. By now it was dark and we had nowhere to go. So the pigs blocked us in at both ends of a small country road and we crashed out there for the night. It was an uneasy night, we could see riot pigs in the field and they kept shining their van lights on us. Everyone was restless, saying 'Oh we're going to be trashed!'

Early next morning a despatch bike went out and found us a site. This time it was council land, great! So off we set again, stopping 1st for fuel and food. As we tried to take a side turn the pigs blocked it and nicked a few people, giving one a good kicking in the process. We held a meeting, should we go on or



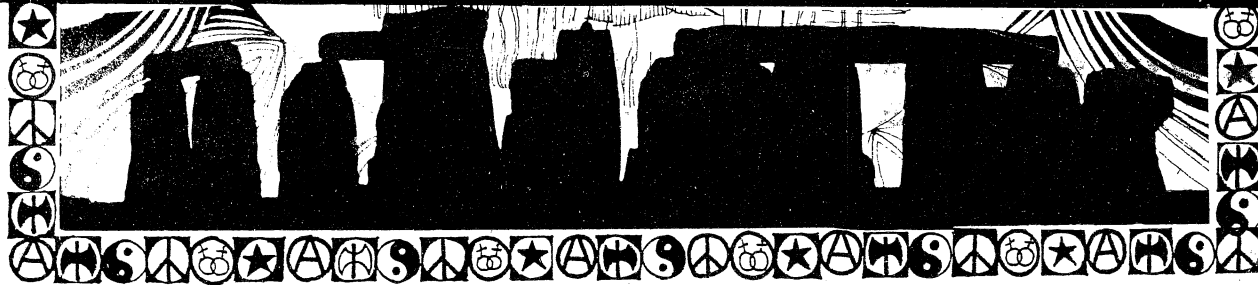
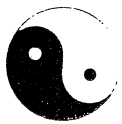

should we go to the nick? People were still very paranoid about being trashed. They forgot that this year the pigs were 'on good behaviour', so in a way we had the upper hand. We got moving again, I went

on ahead and did a decoy down a side road, fooling the pigs into thinking we were going there rather than further on.

We chugged along, but had the bad luck to have about 6 breakdowns, so we sent an advance party of fast vehicles to take the next site at Hanging Langford. We overshot the site. I stopped and told everyone to turn in, we'd got the site, and we could

tice ceremony, even the druids did their aloof little piece.

We gradually regrouped at King Samborne in Hampshire. On Sat June 21st most of us were released on bail, the Brixton crew were all back together. That night we were all entertained by a magical storm of sheet lightning, which, when it flashed was as good as daylight. We each took it in turns dashing out of the tents to stir the dinner, which was bubbling away on the fire.

We gradually got ourselves back together, people came out of nick, impounded vehicles were retrieved from the compound, people got their tents and



keep it for a while! The walkers arrived and we towed the breakdowns to the site, someone else went to check on our friends who'd been nicked.

People unwound from the stress of the night before, some hash arrived and we all got happily wrecked, watching some of the most awful music I've ever heard. The site was great, right next to a lake, the people were great too. We had a site meeting every day, someone did a communal wood run, shit pits were dug, free food was available. We swam in the river, it was great...We made a small space where people lived together quite happily without authority, we'd made anarchy!

As the solstice approached our minds turned to getting to Stonehenge. Locals came and showed us a different route to Yarnbury Castle, some people secretly decided to leave on Thursday night when the cops wouldn't expect it, but unfortunately there wasn't enough of them so it didn't happen.

We left on Fri morning with 100 vehicles in a line and 100's of walkers. People cheered us as we made our way up the A36. I was zapping up and down the convoy like mad trying to keep everyone moving (nearly impossible at times!) As we crawled up the A36 we came to a roadblock of about 200 pigs. They told us to disperse or be arrested, we laughed at them. I rode off trying to find a friendly farmer, but he was impossible to find (he had offered us a site). By the time I returned the pigs had moved in and nicked over 200 people (and many vehicles) in a very nice way, as if they were on a CND demo. They even nicked some of our friends from Brixton. People were then scattered in all directions, not knowing what to do or where to go. Some of us squatted a field, but were soon kicked off by the police, then we were even more dispersed. During this I got to touch the Chief constables hand, who accused me of being the leader of one of the groups!

That night people got to Stonehenge in dribs and drabs, there were a few hundred there for the sol-



sleeping bags back. We managed to unwind a bit down there, despite the shit we got from a group of travellers who had established the site, who viewed us as outsiders to the festival scene, despite the fact that none of them had made any effort to get to Stonehenge or establish a festival.

I left a few days later, feeling very happy. It had been worth the nine months work. We didn't get to Stonehenge en masse, but we knew we wouldn't. But what we 1000 or so who bothered to turn up did was just as good...We showed that by standing together we are strong. We proved to ourselves we can live without the mind numbing effects of authority, and get on by working co-operatively together. I hope the people involved will build on this experience...We went for

STONEHENGE

# PULLENS VICTORY

The Pullens resistance and resquats were a great Victory. But it seemed bad to us, as we came late at 10am to find we were evicted, cop saturation and rain rain rain. About 100 of us were blocking doors, raining, stabbing tyres. It was SLOW, heavy barricades! Rain stopped & band struck up merrily again. More paint splatters the pigs, cheering as they hit the next door. Van Burgh removal lorries, council, TV, thugs, scabs & wall to wall FILTH. It took too long each door had to be smashed to bits, by 12noon they still had 5 flats to evict. In fact we were actually winning!

Pullens (cont Pg 12)



# D.I.Y. TRANSMITTER PLANS

## 4w complete

**THIS IS IT!!** After years of messing about. Do It Yourself Plans for a simple FM Radio Transmitter. (Courtesy of Radio Crimes and Free The Airwaves). This design gives about 4 watt output, which is plenty to start off with, if you can get up high. The parts shouldn't cost more than 35 pounds (excluding test gear). For the more ambitious Radio Crimes will soon be publishing a design to take this transmitter up to 30 watts power.

### 4 watt VHF transmitter, parts and instructions

\* Get some *double-sided copper clad PCB*, enough to make boards in *diag. II and IV*, and a piece  $1\frac{1}{2} \times 3$ ". Cut PCB with *stanley knife* - score, bend, snap. Cut islands with *junior hacksaw*. Clean with *emery cloth*. Drill holes  $1/8$ " bit. Mark islands with felt tip A to X (see diags. II and IV). Mark board with islands with *Lochte superglue* - one drop will do. Clean islands of any glue. Apply liberal amount of *solder* to islands with a decent *iron*, 25 watt Weller is a good buy, small style.

1. *3SK51 or 40673 du. t-gate mosfet transistor*  
Cut two legs off to about  $2/10$ ", opposite sticking-out bit. Apply solder. Try not to handle transistor, but use legs to position. Stick these legs to islands B and E. Cut other legs, press down and solder to islands D and F.
2. *33pf capacitor*  
Same principle, cut one leg, apply solder, use other leg to position.
3. Wind 2 x *33pf* capacitors legs together. Solder to islands F and the negative rail, which is the board.
4. *330  $\Omega$  resistor, 1/4 watt (orange/orange/brown)*  
Keep close to 3, island F to board.
- 5/6/7/8. *4 x 220K  $\Omega$  1/4 watt (red/red/yellow)*
9. *33pf*
10. *56pf*
11. *BB105B or BB205B varicap diode*  
Spot nearest island.
12. *9V1 zener diode*  
Line nearest island.
13. *4N7 capacitor (or 4700pf, or .0047uf)*
14. *68K  $\Omega$  (blue/grey/orange)*
15. *.1UF capacitor (or 100N, or 100,000 pf)*
16. *110  $\Omega$  (brown/brown/brown)*
17. *Single piece of insulated 3-amp wire*
18. *2-22 pf foil trimmer/variable capacitor*  
Odd leg is positive and goes to island G
19. *MC108 Toko VHF mounted coil inductor 5.5 turns, 0.64  $\mu$ H*  
This is the most tricky component in the circuit, due to difficulty in raising ferrite core. Sharpen a piece of plastic with Stanley Knife to act as trimmer. Be patient. Order a number of different coils near this one, so that you can experiment, as it is this component and the variable capacitor above that combine to create the frequency for transmission.

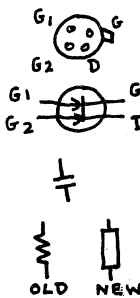

**RF choke, fixed inductor**  
This isn't ready-made, but you have to build it yourself. Get a dozen *FX 1115* ferrite beads and some *28-gauge, enamelled SWG copper wire*. Wind wire through middle 6 times. Remove enamel from the ends, best way to do this is to burn off then use emery cloth.

21. *56pf*
22. *10K  $\Omega$*
23. *4N7*
24. *2N3866 transistor*  
Before bending legs into right position relative to islands, we must *heatsink* transistor. Small heatsink will do. Plus we need *silicon grease* in a syringe. Put grease around sides of transistor can, prise open heatsink with screwdriver, slide tranny in, take out screwdriver. Bend legs and cut. Solder. Make sure with crossover that no legs touch.
25. *18-gauge enamelled SWG copperwire*  
Wind wire 9 times around pencil, shape legs, scrape off enamel and solder.

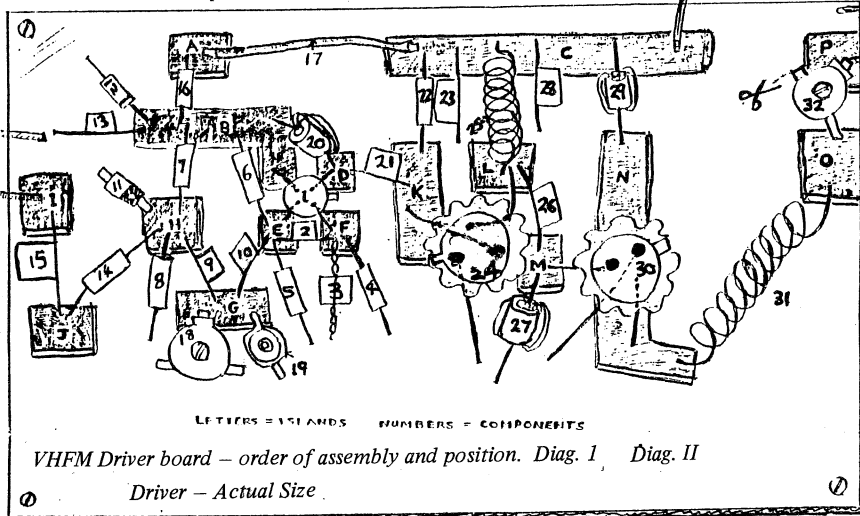
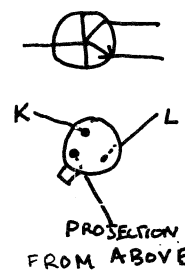

28. *4N7*
29. *RF choke, as above*
30. *2N3866* The larger the heatsink, the better.
31. *SWG 18 gauge enamel copperwire* 10 turns this time.
32. *2-22 pf variable*  
Positive leg to P. Cut off leg facing leg on O.
- \*\* The first board can now be tested once we have added piece of *UF67 Coax*, or any heavy-duty 7mm CB Coax. (See *diag. V*). We must fix Coax to a *UFH* male plug (see *diag. VII*). Plus we need *stereo 1/4" jackplug socket* plus *250K  $\Omega$  log pot* and some insulated 3-amp wire.  
To properly test and develop we need:  
a) a *power supply* - a CB 13.8v 3-amp unit, or a 12v car/motorbike battery.  
b) a *power/SWR meter* - capable of up to 150MHz, *plus dummy load* up  
c) A *frequency counter*. This is the most expensive item. A *Thandor PFM200A* is the best value  
We could do without a frequency counter, but if anything is slightly out, ie off the VHF band, than a radio receiver is no good to find a fault.  
d) A *cassette-player* with a 5-pin Din plug.  
e) A *radio receiver*  
Fit to power supply, fit to power meter. Turn on frequency counter. Set counter to 0.2 gate, put probe into left-hand socket (probe can be just a piece of single core insulated wire). Turn on power. Adjust parts no. 18 and no. 19. See the reading change. Choose a free frequency. To adjust power, turn part no. 32 (to adjust variable capacitors, use a plastic trimmer).  
If all's going well, plug in cassette (5-pin Din plug to 1/4" jack Tandys). Put in your favourite tape, turn on radio, and if everything's okay you should hear your tape on the radio. If something is wrong, check and double-check. If you can't work it out, send board back to us via *Free The Airwaves* and we will see what's wrong. If everything's okay then you can go to the next stage.
33. *3-90 pf variable capacitor (foil trimmer).*
34. As above
35. *2 and a half turns of 18 gauge tin coated SWG using a 1/4" drill as former.*
36. *47  $\Omega$  resistor.*
37. *RF choke, same components but only 3 turns.*
38. *MRF237 transistor* Large heatsink.
39. *4 turns 18-gauge tin-coated SWG Pencil former.*
40. *10  $\Omega$  resistor*
41. *.1  $\mu$ f*

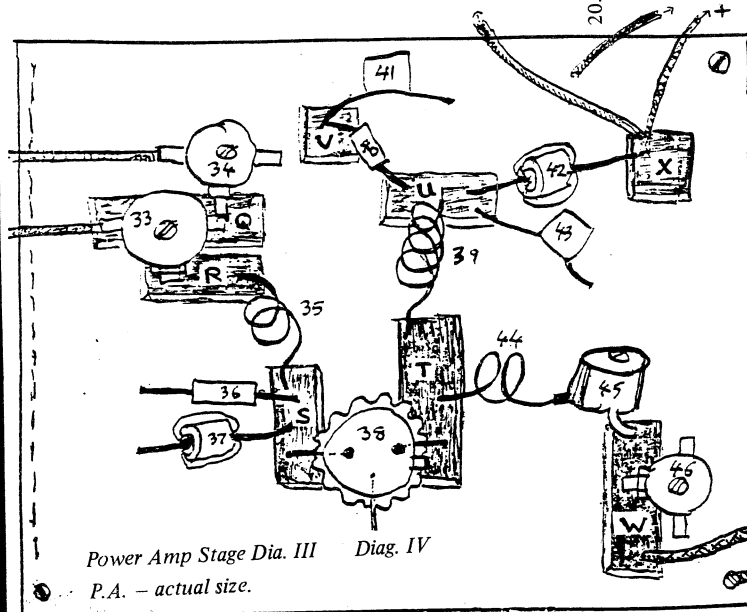

Approximately 480 one - mile - radius local VHF M commune - igation stations are possible in London. In the most dense areas we are talking about 50,000 people, eg. the Elephant and Castle district. For less dense areas, where, say, only 12,000 people live in a 5 - mile radius, we are trying to develop a 10 watt transmitter. Again, if anyone knows any useful information, don't sit on it, give it to Free The Airwaves.

# radio

Anyone who has any better ideas, why not let us know so we can make them available. Or, if you have any queries, or want to get parts, or even ready built, please write.

Best place for parts is either: The Circuit Catalogue, Maplin, RS and/or HRS Catalogues. Or ask your local supplier to order the parts.

**THE LATEST 'RADIO CRIMES' IS OUT NOW'. FOR NEXT 3 COPIES SEND MINIMUM DONATION. £2 (For organisations £10) for next 3 ISSUES. to : FREE THE AIRWAVES, BCM BOX 1502, LON. WC1N3XX..**

Aerial design

Diag. VII

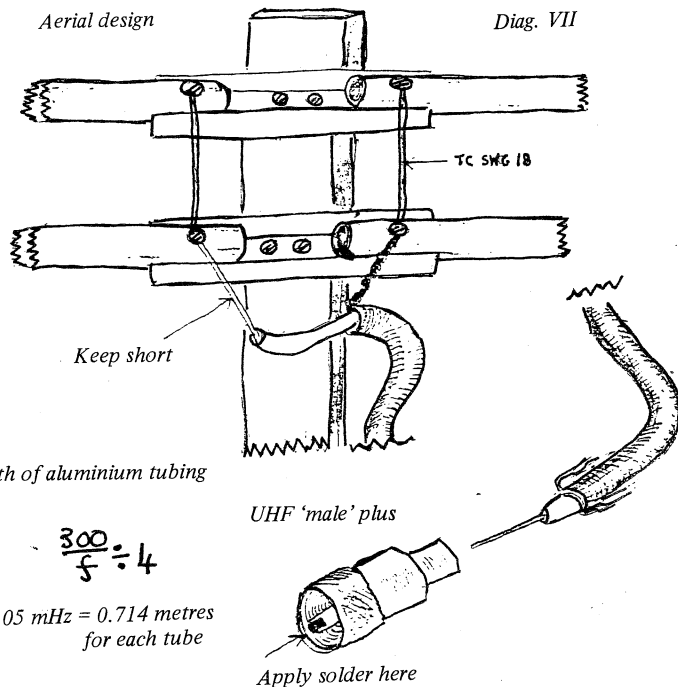

- 42. N18 (or 180pf)
- 43. RF choke - 3 turns
- 44. 2 turns 18 TC SWG Solder directly to positive leg of part no. 45, which is a 3-90 pf trimmer. Cut off leg facing away from island W.
- 45. 3-90 pf trimmer

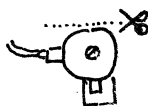

\*\* We are now ready to fit into a box (see diag. VI). Get 8" x 3" x 1 1/2" aluminium box. Drill holes. To put in divider, solder along dotted line in diag. 111 and solder along side of divider. Don't solder together yet. Solder TCSWG18 wire between earth and islands P and Q. With the second wire make sure there is no contact with earth. Now solder divider, also making sure no contact with P and Q connection. Last points to solder, using same wire: from island W to centre of UHF female plug, and from earth to outer. Solder 4N7 capacitor from the stereo plug to earth. see dia. VI for positions)

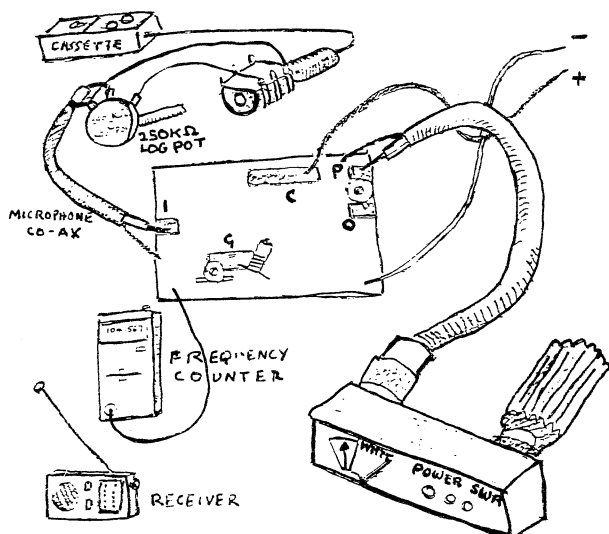

Testing Driver Stage Diag. V

If alls well on testing, using same procedure as with first board - you should get nearly 5 watts with the 13.8v supply. To trim up power, go through each variable capacitor starting from island P until you get the maximum reading from each capacitor.

Now you must make an aerial. Get 10 metres of UR67 Coax. 4 metres of 1/2" aluminium tubing (either go to a specialist metal supplier, or get an old H or X 407 VHF TV aerial). Cut to the frequency required (see diag. V11 for calculation). Plus we need some 1/2" electrical conduit and about 3 feet of 2" by 1" wood.

To tune aerial to its maximum efficiency, we want a setting nearest to 1 on the SWR scale. Experiment first with dummy load. Remember, maximum watts and a rubbish SWR reading won't help you get a better signal.

To test press SWR button, press SET button, slide scale till the meter reads SET. then press TEST button- if its properly tuned, the needle will drop to 1. Now try with aerial- don't worry about power reading- with a setting of 2.5 SWR, this will get you over a mile with a 12v battery. Try aerial in different positions and locations. The best results will only come with experience and experimentation.

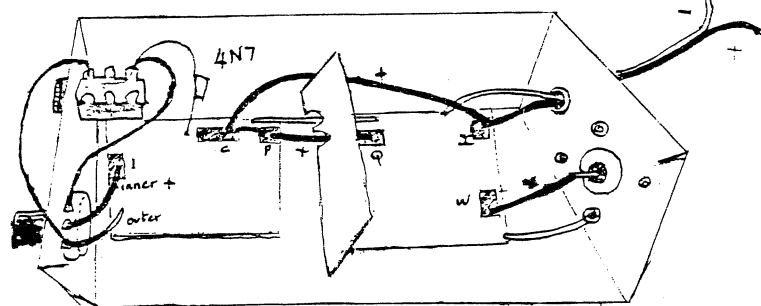
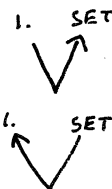

Wiring positions in box

Diag. VI

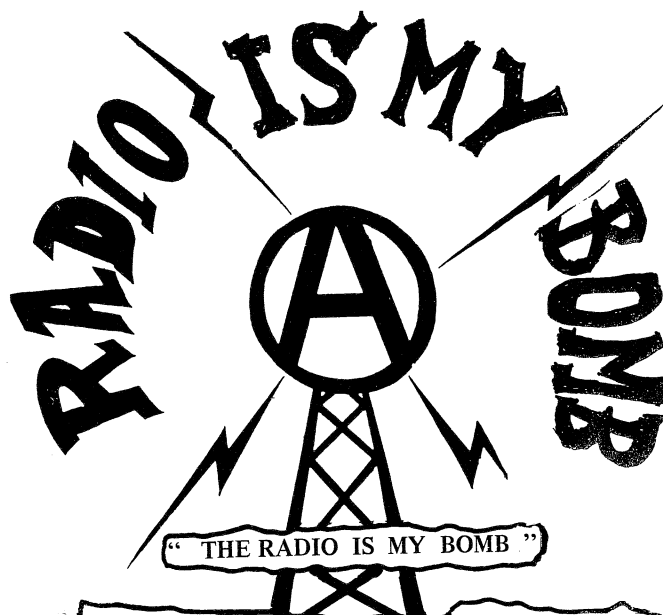

A Complete Do It Yourself Guide for the radical Radio Pirate. Including step by step plans for building FM transmitters (up to 80 watt ), aeriels, Medium Wave, etc. With a practical 'How To' guide on all aspects of pirate broadcasting, programme making, the law and how to get away with it.

Plus features on Free The Airwaves and Local Pirates, the history and present in Britain, anarchist and overseas pirates from around the world.

Planned 96pp. £1.80 from Hooligan Press. Out Oct. 86

# Letter From New York



WITH A WIND CHILL FACTOR OF ABOUT -25°, A HOMELESS WOMAN WAS EVICTED FROM SITTING IN PORT AUTHORITY BUS DEPOT. SHE WAS FOUND FROZEN TO DEATH THE NEXT MORNING, JUST OUTSIDE THE DOOR.



PEOPLE ARE BEING JAILED UP TO A WEEK, FOR BRUSHING THEIR TEETH IN THE BATHROOMS AT GRAND CENTRAL OR PENN STATION.

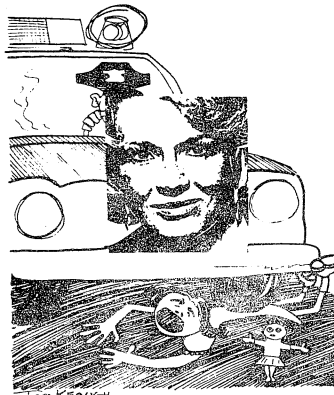

A 9 YEAR OLD CHILD WAS RUN OVER BY A POLICE CAR. AT THE PRECINCT HOUSE, OTHER COPS REFUSED TO FILE ANY REPORTS THAT SAID A POLICE CAR WAS INVOLVED



A COP NAMED SULLIVAN MURDERED ELEANOR BUMPUS FOR BEING LATE WITH HER RENT.



COPS SNEAK UP BEHIND HOMELESS FOLKS IN THE TRAIN STATIONS. THEY CHAIN FOLKS TOGETHER. WITH NO ARRESTS SOMEDAYS. THEY MARCH THE PEOPLE UP & DOWN THE STATION, UNTIL JUST BEFORE RUSH HOUR. THEN FOLKS ARE PUT IN JAIL FOR A DAY OR TWO. AT ARRAIGNMENT, CHARGES ARE USUALLY THROWN OUT.



OVER 400 NY POLICE AND FBI AGENTS ARRESTED 8 POL ACTIVISTS. AT MIDNIGHT, THE COPS SEALED OFF THE BLOCK OF THEIR NEIGHBOR HOOD. EVACUATED THE NEIGHBORS. GRABBED THEIR CHILDREN, DENIED THEM OF ALL RIGHTS.

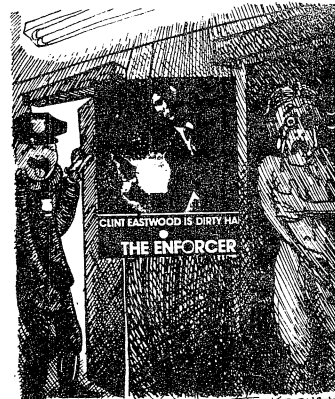

IN SHEEPSHEAD BAY, BROOKLYN, 3 DAYS AFTER ELEANOR BUMPUS WAS MURDERED BY THE COPS, TWO WHITE COPS EVICTED AN ITALIAN AMERICAN WOMAN NAKED! AIR TEMPERATURE WAS ABOUT 40°



MORE RACIST TORTURE AT ANOTHER QUEENS PRECINCT.



RACIST TORTURE WITH AN ELECTRIC STUN GUN. 106TH PRECINCT, QUEENS



AT A BAR IN BROOKLYN, FIVE OFF DUTY POLICE MEN ACCOSTED A WOMAN CUSTOMER. HER FIANCEE COMPLAINS AND IS ATTACKED AND PISTOL WHIPPED.

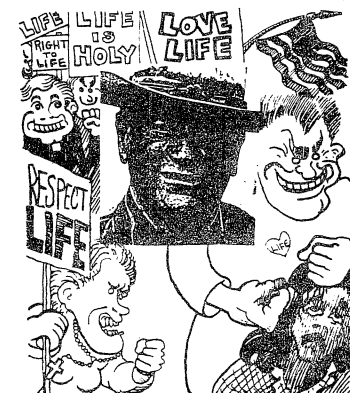

AS A MEMBER OF A "RIGHT TO LIFE" GROUP PICKETING OUTSIDE OF AN ABORTION CLINIC, AN OFFDUTY COP SEVERELY BEAT A WOMAN WHO HAD CHOSEN TO ENTER THE PLACE.



ON THANKSGIVING DAY, TV GAVE A LOT OF COVERAGE TO THE CASE OF A POLICE OFFICER WHO HAD AT LEAST EIGHT WOMEN, RAPED THEM, THEN THEM. UNFORTUNATELY NEWS COVERAGE EMPHASIZED "15-A BLACK" AND DOWN PLAYED THE FACT THAT HE



-Pete has been FUCKING INCARCERATED for being an @ and anti-racist. We are furious. We reprint some of his faction cartoon strips -so FUCK OFF PIGS-You can't shut him up.

PETE has been hounded by Special Branch for the past year since 'Stop Henley' where he was nicked, photographed and accused of being a 'Leader' of 'Class War'.

He is not even in C.W. They caught him again last year while they were beating the Convoy to shit, nicked his camera and did him for the crime of 'Criminal Damage to a Bean-Field' (A case still to come up).

Since then they have been on his trail, determined to do him for SOMETHING. Someone high up had said STOP THOSE TERRIBLE DRAWINGS.

They came round to his home SIX WEEKS after the anti-apartheid demo, got in and showed him pics of him at the demo, throwing 'a small black object' which he said was a mars bar.

THAT was the worst photo. He got 3 months, and the sentence was confirmed at appeal.

ON 30th Sept. last year, Pete was walking home just after the uprising. Riot vans were cruising the streets, doors open. They left out, grabbed two other passers-by and Pete, who was just opening his door. They accused them of looting the off-licence on the corner which had been smashed HOURS earlier. BUT they had no evidence.

The sergeant sent a WPC to the off-licence and she took a six-pack from the wrecked window.

THAT was the evidence and Pete was arrested. This ridiculous but heavy looting charge is coming up shortly at the Old Bailey.

# PIRATE

The Crackdown continues. Armed with new laws and the Police Bill, and flash new detection gear, the DTI (Dept of Trade and Industry) and the fifth have been busting pirates and even their studios right left and centre.

Community Radio (CR) is dead. The CR industry mushroomed since last year, with 127 outfits applying for the 5 local licences (with many strings attached) offered in the London area. They were supposed to announce the winners last Feb - but delay followed delay - till Douglas Turd announced that the whole scheme had been dropped - basically cos he thought lefties were disguising themselves as straight groups to go for a licence.

We certainly hope that all these groups (music, community, lefties, 'ethnic', etc.,) will now GO FOR IT and become pirates! So flooding the airwaves that they cannot be stopped.

The Free The Airwaves campaign has recently been calling for local pirates, as the best way to break through the Crackdown.

The above 4 watt design only goes a few miles, yet locally you may be the loudest clearest station! There's no more reason why every anarchist, squatters, womens, ethnic, etc... group shouldn't

# FREE PETE

## FREE PETE MASTIN

Please Write: Peter Mastin, N86881.  
Pentonville Prison, Caledonian Rd.,  
London N78TT.

PETE MASTIN

Support Pete

Doing 3 months for 'Threatening Behaviour' at an anti-Racist demo. Please write to him and cheer him up - then send anything else ie all your money to 'PETE MASTIN DEFENCE FUND' C/o BM BOX HURRICANE LONDON WC1

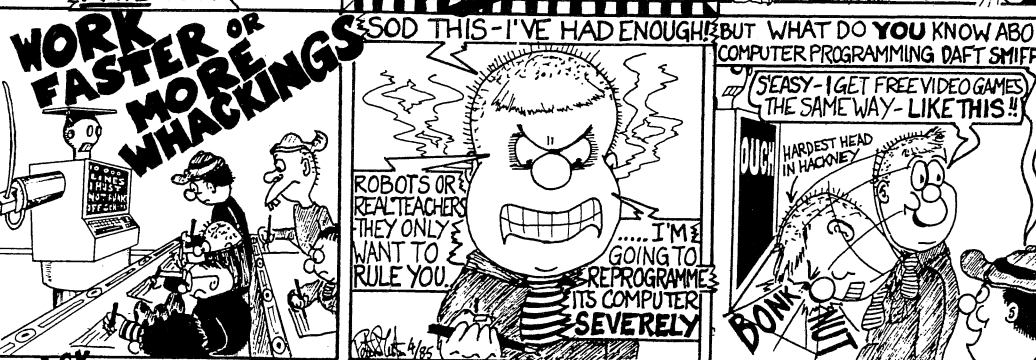
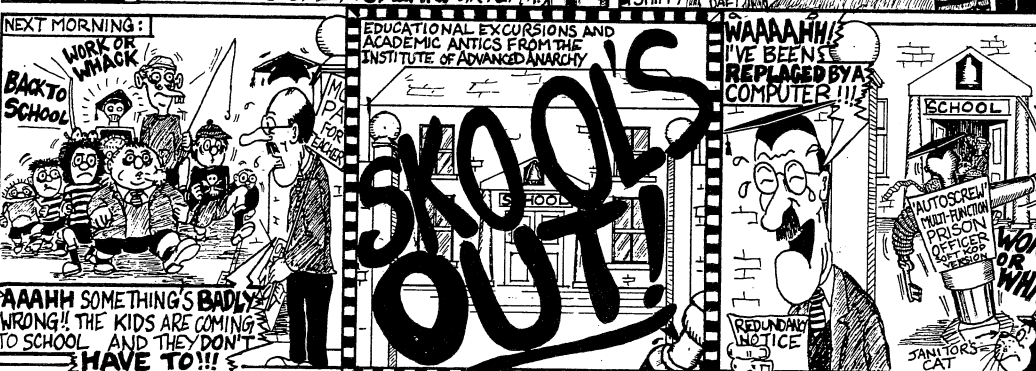
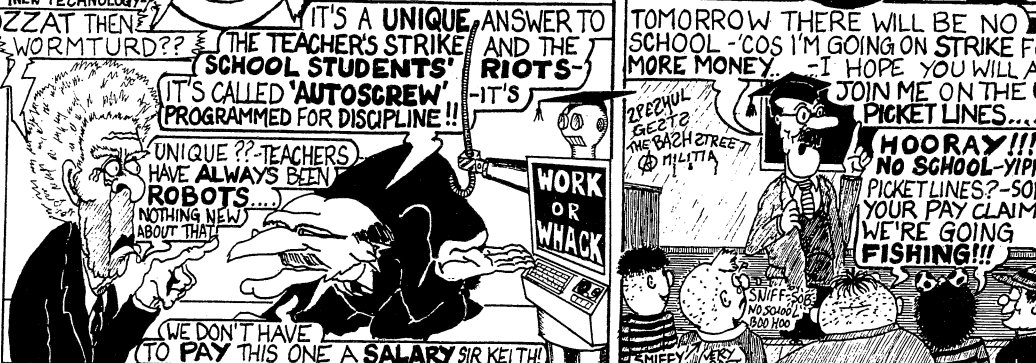
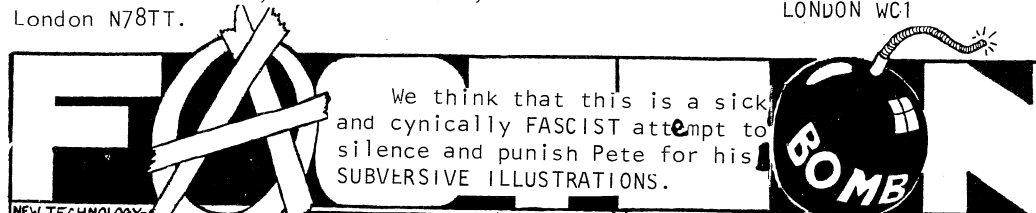

# radio

have their own transmitter..until, as happened overseas and with CB here, the law becomes a complete farce. There is room for 480 1½ square mile pirates in London, even on the present restricted waveband!

For the guerrilla pirate 'break ins' are all the rage, in the line of Radio Arthur and Radio Wapping. For this you really need more power, but at least locally its quite simple to break into , for eg the LBC nine o clock Lies with your own short message. (But make it SHORT, you could go to jail if caught!).

# CROWBAR

No. 47

Pullens... ctd.



then a thought began to occur i.e. How can a council allocate smashed up flats with no doors to tenants at 2p.m.....

'FUCKOFF, YOU SCABBY SCUM' I yelled at the officers yet again 'Go on strike, they'll have you murdering Jews next week'. Indeed the pigs were not enjoying this one as they were met in the last street with buckets of cold water

'WE WANT PETROL' We shouted, as the sound system blared out 'Anarchy in the U.K.' from the barricaded flat (They got in, nevertheless, by sheer brute force, though at the next flat they had to give up... There were solid concrete blocks preventing the scum from entering!).

Bailiffs, council thugs and piggies all lined up and then pissed off as we jeered and cheered from the side street. We all went back to the Pullens Centre for coffee and a meeting. Many squatters had crashed out after being up all night, but the place was packed and downstairs was full to the ceiling with evicted possessions and furniture. Outside the streets were littered with peoples furniture. For the evict-

ion had been too late, too slow, and above all too much bad press for a council that strives to be seen to work for the poor and oppressed! They had given up on the plan to move peoples stuff out the area on the hire fleet,

A few squatters got up and talked at the meeting, explaining that no-one would be affected by 'PIO' orders if the flats were re-taken by 2.30pm, and proposing that people who wanted to re-squat with them, put down their names and numbers..and volunteers and tools would be gathered. Then Piers Corbyn (The ex-squatters leader, now a Southwark Councillor) came in with some politician friend of his. I was surprised that the meeting didn't immediately throw them out of the window but apparently Piers had been arrested, albeit briefly, for trying to let the tyres down on a removal van. He and his friend 'took control' and proposed that we should wait until they had been and pleaded with the council on our behalf..and that the evicted should put down their names to be rehoused in the evicted squats... Luckily they left and we got down to business with a list and a crowbar and set out to re-squat.



Riot police preparing for trouble during the evictions and a paint-splatter officer at one of the squats.

It was all so easy, with few cops about, and in ten minutes, we'd ripped the boardup crews

best efforts off half-a-dozen squats. One was immediately re-squatted but there was no sign of the other evictees. Then we started carrying furniture back into squats, phew, what a job! Then we found a woman ready to move back in and set out to put a new door and lock on her flat - No easy proposition as the old one was in little bits, the door frame badly damaged and the promised tools had'n't arrived. But the magic of Pullens worked again... that is to say that a couple of years back the Pullens tenants had invited squatters to move into empty flats, and half the squatters had become legal tenants in this way. We only had to knock on a few doors and we had all the tools we needed. In fact we spent the whole afternoon working on that one door... What with finding a door, cutting it to size repairing the frame, fitting a lock, etc, etc... But all the flats were resquatted by the deadline, at least symbolically, by sticking something in the doorway with a legal notice on it... And we had the TV cameras there to prove it! The media coverage was extensive and fairly friendly (Fuck the Guardian). Thames IV even filmed an eviction from inside as the door was smashed down! The media were there thanks to the hard work of the Pullens Tenants Assn. and SNOW. They were friendly, especially the South Lunnun Press which has always hated squatters! ... But because it was a chance to attack a split in a Labour council, not that we cared about that! In fact the council couldn't even find scab tenants to take most of the flats. (The one we repaired had been repeatedly offered to a friend of the squatters, who had been living in it for 6 months, with threatening letters that he wouldn't get offered one again). A few would-be tenants turned up, and immediately left amiably when the situation was

explained to them. One bloke showed up, desperate, and said they threatened to have him deported to Nigeria where he faced trial, if he refused one of the flats. He was helped out.

Pullens is still squatted, it's a wonderful place, why not drop round to the centre and have a look round. Pullens is where the squatters stood firm with goodwill and good tactics from start to finish - 'Pullens Lives' should be our battle cry and our taunt. \*\*\*\*\*

At the same time as the Battle for Pullens a 'normal' mass eviction was happening at nearby Rockingham Estate, with 22 flats evicted in scarcely an hour and then secured by the council with Security Guards on duty.

However, fresh from victory at the Pullens, supporters went to Rockingham at midnight to resquat the lot. 5 of those resquatted were re-evicted next morning, with bailiffs and council spouting 'PIOs' and 'Restitution' and Piers Corbyn spouting 'Illegal Eviction'. Only 8 of those resquatted could be firmly held.

## SPLIT LABOUR STILL EVICT

The reason all these evictions happened together was that the mass eviction orders were almost out of date. In the Local Elections rival Parties had vied for votes by bashing squatters. Now, after Pullens all had changed, or had it? The Labour Party Executive and even the Leader of Southwark had come out AGAINST the evictions to the media.. Yet scarcely a week later the bailiffs & pigs moved in on Kinglake & Alvey Ests, the heartland of SNOW!

We didn't get word and missed the action. What happened briefly.. the whole show turned up at 7.00am to evict, but squatters and tenants had dragged skips across the entrances & were ready to resist. They all pissed off. VICTORY! But returned a few days later by surprise and evicted the whole lot. In the end about half were successfully

SOUTHWARK PULLENS VICTORY





CROWBAR

THATZER

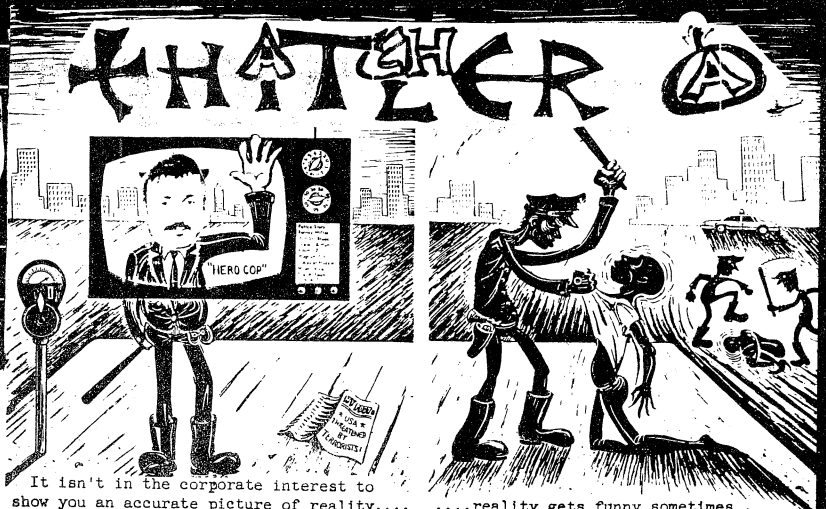
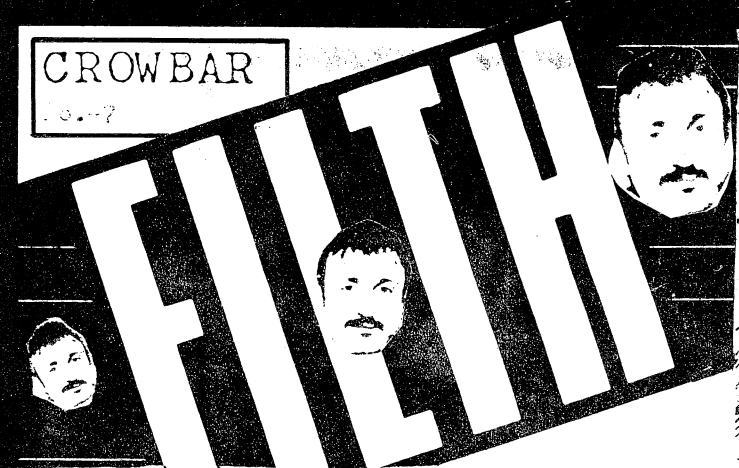

It isn't in the corporate interest to show you an accurate picture of reality.... reality gets funny sometimes.....

The police OP on 24th July was the end result of the pigs whipping up false public hysteria that 'armed drug dealers' are openly selling heroin and murdering each other on the streets of Brixton', and the police Tacticians whose job is to create as much DIS-order as possible as an excuse to get even more cash in their pockets (they got a 7½% rise the same week) and for tooling up to oppress the people even more!

### KILL ALL RACIST SCUM

Police teams then searched the sewers and sniffer dogs checked out the building to find any drugs left behind in the commotion (or by the police). The end of the siege was signalled by the D11 armed squad beating a retreat before the TV cameras arrived (though they blocked off the road for another 3 hours), they had packed their guns out of sight in neat blue bags, and I suspect the green bags in the back of their blue van contained their new riot guns. Next the riot pigs pulled out, climbing into the hired BRS lorries, making mock ape and monkey noises. After that tons of filth appeared from nowhere (they must have been the police from the train) and got into waiting coaches for doggy bags and congrats from the super. Taking advantage of the diminishing police presence a near riot ensued with a loud firework and a few bricks thrown. The OP was coordinated from bases set up around the area, the coaches used were seen parked around Brixton the day before.

The police's occupation of the frontline was symbolic to them as in previous riots they have had to take it back from the people and its timing was perfect to catch on to the patriotic hysteria that was stirred up by the Royal Bastards getting married the day before, with all the accompanying pompous shite, and the Daily Mail readers lapping up the sour milk and total lies, published to aid ailing circulation, going on about drug peddling, gun toting political crazies on the streets of Brixton (the police found, or planted one pistol in the raids). The police attack was designed for maximum force and no questions in parliament whatever happened (the 'recess began next day) in an attempt to trash the whole of Brixton over the following weekend..on the day AFTER the raid a police bulldozer, coaches, about 20 green riot buses, armoured land rovers and fuck knows what else were still parked up on Upper Tulse Hill Rd.

This is another attempt to stir up inner city racist tension by the fascistic media and nazi police, so that 'Revenge Riots' can be suppressed with their new long batons, riot guns, tear gas and heavy sentences for rioters. Does this mean that every inhabitant of Brixton, Handsworth, St Pauls and the Mets 'top twenty' riot flashpoint estates will be arrested for LIVING in a riot zone?

### SaBoTaGe THE MaChine



### STICK A PIG CAMPAIGN

MANY, Many apologies to the 100's of our readers who've told us just how objectionable they found the cover on No. 46. The policeman's head in question was supposed to look like it rested upon an F.A. Penalty Spot, and not on a dinnerplate as so many of you thought! Crowbar Sez; STOP THE MET. PLAYING POLITICAL FOOTBALL WITH DEAR OLD P.C. BLAKELOCK.

# GREEK

# FIGHT

# BACK

CROWBAY

No. 4

## Greece - 5 On Hunger Strike

The crisis in Greece is still growing more desperate daily, with the discredited 'socialist' government, now a pawn of the US and the World Bank, unleashing a new wave of economic repression and strikes threaten to bring the whole place to a halt. Greece is no holiday in the sun if you live there. The fascist movement is reviving fast, openly aided by the police. Meanwhile the state is mounting a fearsome police campaign against the extra-parliamentary opposition, ..the independent left, the punks, feminists, but above all against the small but strong and combative anarchist movement.



The anarchists in fact have occupied a key space in the resistance, and the war against the anarchists is rarely off the front pages. The police have tried mass arrests, routine and horrific torture and lashings, huge raids and occupations of the Exarchia Sq, anarchist area of Athens, frame-ups, black propaganda, beatings and straightforward murder on the streets.

But the young militants just will not shut up, and on occasions (eg the Tech. University Siege when they threatened to blow up the building & themselves to gain the release of hungerstriking comrades in prison) they have received wide support and become an inspiration for the strikes and protests of the working people.

The latest round began on May 9th, when the @'s had a march against nukes, as Chernobyl radiation spread south across the peninsula. The police charged the demo, brutally beating and arresting 11 people. Next day a similar demo was again viciously attacked. 2 days later the police tried to charge the @ section of a big lefty march against nukes. This time they got petrol bombed, with bikes burnt and nine cops hurt, but 39 of us arrested. The war had begun again.

In the following days 13@'s were tortured by lashing in prison, dozens more were nicked, at a Salonica festival and in another police raid on Exarchia Sq in Athens etc.

May 25th was the fascists day, with big demos in most cities demanding dictatorship. Police and fascists joined together to attack the anarchist counterdemos, seriously wounding many comrades. Then 4 @'s were nicked in Lamia for distributing an anti nuke poster, and 6 got six months prison each for demonstrating against the fascist Le Pen's visit back in 84.

On 1st June we hit back, destroying the presses of the Gov. paper Exormisi in a big arson attack claimed by 'Anarchist Action'. And on 5th June the Salonica comrades squatted the Industrial Studies School, threatening to blow it up if the police attacked.

From here we go to Black Flag No. 158.

As we reported in the last issue of *Black Flag*, dozens of Anarchists have been arrested over the last two months in a crude attempt by the State to break the back of the Greek anarchist movement. As we go to press, twenty-one anarchists remain in prison facing a variety of charges (including attempted murder) and many have been tortured (two so badly that they now have difficulty walking properly). Five anarchists went on hunger strike on June 17th in response to the tortures and beatings and would obviously appreciate any form of solidarity from Britain or elsewhere (see below).

Eleven of the twenty-one arrests were made during an anti-nuclear demonstration through Athens on May 13th while the others were arrested in Salonica after a petrol bomb attack on a police car on May 19th, (two policemen were seriously injured in the attack, hence the attempted murder charge).

To continue pressure on the anarchists, Katarina Latropoulou (a well known anarchist lawyer from Athens) was arrested by police on June 22nd in a vicious frame-up. Police have linked her with two escaped prisoners who they claim she helped while they were on the run. Drug squad officers also planted heroin and hashish in her home to ensure a heavy sentence if she is convicted. The case, known popularly as a police fiasco, has caused so much public controversy that both Greek Prime Minister Papandreu and his Minister for Public Order have been forced to make public statements about the case. Predictably, they claim the arrest was totally justified and also hinted that Katarina had links with the terrorist world as well as the drug scene.

In response to this latest frame-up,

three thousand people gathered outside the University of Athens and marched to the houses of parliament on June 26th in solidarity with Katarina. A second demonstration was organised by anarchists on July 3rd but it was banned by the police and a police cordon was thrown around the university of Athens for several days to ensure more demonstrations would take place.

Despite the cordon, four Anarchists managed to slip through and display banners denouncing police repression on July 3rd. Fifty more Anarchists broke through the cordon on the following day and held a press conference in the university.

On June 1st an incendiary bomb exploded outside the ruling socialist party's newspaper office, causing fifty million drachmas worth of damage. A second bomb exploded outside the Young Socialist's newspaper office a week later. Both actions being claimed by the 'Anarchist Action' group to underline growing police repression.

On June 23rd a third bomb exploded outside the Ministry of the Environment causing extensive damage. This bomb was claimed by the 'Revolutionary Popular Struggle' group in solidarity with the Exarchia Square Community (a meeting place for Anarchists in Athens).

The 5 Anarchists on Hunger Strike are:

1. Yannis Balis
2. Basil Maganadelis
3. Tasos Kypreos
4. Andreas Barboutis
5. Panayotos Galanakis

Direct protests to: The Greek Embassy,

Greek Embassy, 1A Holland Park, London W.11. Telephone 01-727 8000

Dear Comrades,  
We badly need your help and solidarity. Write letters or phone the nearest Greek Embassy or Consulate.  
Minister of Justice, Apostolos Kaklamanis-Zimonos & Sokratous Str., Athens - GREECE  
• Minister of Public Order, Antonis Drosoyannis, 1 Katehaki Str., Athens.  
• Prime Minister, Andreas Papandreu, Athens - Greece.  
• President of the Republic, Christos Sourtzetakis, Athens, GREECE.  
Try to mobilise public opinion or Amnesty International branches in your countries.

Act as soon as possible.  
Love and anarchy,  
Anarchist Groups of Greece



# Adopt a Prisoner

Here is a list of current Class War ALF prisoners. We're not printing the addresses as they keep moving them about. (As they do with all political prisoners). But you can and should write to them too;

SARP  
BCM BOX  
5911 London WC1.  
Who will forward your letters.

When writing, remember all mail is read and anything indiscreet could cause punishment to the prisoner. Keep writing but don't expect immediate answers.

Committed prisoners can only send a letter a week and that's usually taken up with family, close friends, arranging visits etc. Send any spare money to; SARP at above address.

# Animal War Escalates

The A.L.F. is now 10 years old, and still the campaign against cruelty and exploitation of animals is growing and spreading, in a situation resembling guerilla war. A.L.F. bulletins are still coming in (despite most of the original press-officers getting 2 year "conspiracy" charges and sentences packed full with news of 100's and 100's of attacks from every corner of the country and beyond. Many of the actions are for publicity, warning and propaganda, but a large number are violent actions against property, with damage adding up to millions of pounds.

This year the police have hit back with the Animal Squads using infiltration, tip-offs, phone-tapping, interrogation etc. to trap whole networks of A.L.F. supporters. Many are in prison more are facing massive fines. But the actions are so widespread, so de-centralised and the activists so dedicated that they have actually increased WE WOULD FILL UP THIS WHOLE PAPER JUST TO LIST THEM!!

The 'ALF' is a general term, the movement includes a bewildering range of Leagues, Groups, Federation, Militias of every degree of militancy.

Many of the ALF and their prisoners, are anarchists. Most squatters are by now vegetarian and the campaigns make a lot of sense to us. Though older and Class War @'s are inclined to

ARSON AT ABATTOIR ALF closes yumm

Paul (Moi) Watkins L64779, (2 1/2 years)

CROW BAR

No. 47

Peter Anderson L64805, (2 years)  
Nigel Crouch N42187, (2 years)

RONALD Ronnie Lee V02682,  
Kevin Baldwin T02959

Sally Levitt D27314, (2 years)  
Debbie Smith D28007, (2 years)  
Della Lowick D28006, (2 years)

Eric Marshall L64806, (18 months)  
Carl Egan E74945, (2 years)  
Boris Barker E74946, (6 months)  
Garl Allen E74947, (18 months)  
Keith Griffin E74948, (2 years)  
Mike Mc Krell E74949, (18 months)  
Julian Webster E74950, (12 months)  
Alan Cooper E74960, (2 years)

Nancy Phipps D28005, 6M

Karl Garside L65137, (18 months)

Sally Miller D22865, (12 months)  
Virginia Scholey D27317 (18 months)

GARY CARTWRITE 6 MONTHS

MIKE NUNN 3 YEARS

Julie Rogers P34407, REMAND

Jim Snook N41998, (2 years)

Nick Sweet N42186, (2 years) moved

David (Duggs) Carre, L64807, (2 years)

Terry Helsby P85326

Duncan Thorpe N41997, (2 years)

David (Duggs) Carre, L64807, (2 years)

Iain McCann,

Ian Oxley T02961, REMAND

Allstair Fairweather L64804, (18 months)

Duncan Thorpe N41997, (2 years)

Eric Marshall L64806, (18 months)

John Curtin F17288,

Shaun Ellis, H25078 9M

Beverley Cowley D27316, (2 years)

# LAB ANIMALS FREED IN RAID

A group calling itself RATS was formed in November 1985 and its primary aim is to raise funds for the Animal Liberation Front (Supporters Group). During the four months that the group has been running, hundreds of pounds have been collected in the street and thousands of leaflets have been given out. The money is distributed as soon as it has been collected.

LEEDS ALF HAS PRODUCED A HANDBOOK CALLED "SNARL!" WHICH INCLUDES ARTICLES, OPINIONS, INFORMATION, ADVICE AND REPORTS OF ACTIONS IN THE LEEDS AREA. IF YOU WOULD LIKE A COPY, SEND 25p AND A SAE TO BCM 1160, WC1N 3XX. IF YOU WOULD LIKE TO SEND A DONATION TO LEEDS ALF, SEND IT TO LEEDS ALF SG, BOX 8, 59 COOKRIDGE STREET, LEEDS LS2 3AW. THE

The role of the Militia is to widen, with actions, the concept of animal liberation, so that Militia style actions will take root in all areas of the country, with nothing short of total revolution as the ultimate goal.

Revolution, Communiqué 3,

ANIMAL RIGHTS MILITIA

# Farm

say put humans 1st, and if only they'd attack the rich and the capitalist system, the ALF has now won hard earned respect from us. And many ALF'ers have come to realise that you won't end exploitation, cruelty and imprisonment of animals, or people without a complete revolution.

Three refrigerated lorries were smashed open and set on fire last night, causing damage estimated at more than £20,000.

## Alight

Forensic experts were today examining the wreckage of the vehicles, which belonged to two firms with depot at the Hollingdean Road abattoir in Brighton, Swifts and Anglo Dutch Meats.

Today, in a phone call to the Evening Argus, the Animal Liberation Front claimed responsibility.

ANIMAL Rights extremists attacked the homes of four University of Surrey staff over the weekend, and have made further threats of violence. In a coordinated series of attacks, the victims' homes were daubed with animal rights slogans and covered with red paint.



GET OUT YOUR  
MAGNIFYING  
GLASSES.. THIS  
IS HOT STUFF!!

# NEDERLAND

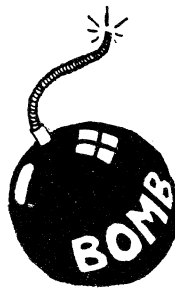

## Nukes For ALL!!

### WAR FACTORY ROBBED

On the night of Wed 19th March anti-war activists did a big raid on MUIDEN CHEMIE, a munitions factory near Amsterdam, and stole all the records revealing vital and scary info on the spread of Nuclear Weapons.

MUIDEN CHEMIE makes Nuke Warhead charges, Neutron Grenades and now a new device, called the BBG, which increases the range of Nuke Artillery by 10km. They're are ready to go full production at the rate of 120,000 BBG's a year (releasing huge quantities of the deadliest poisons). The new factory, the RDM site, had its opening disrupted by more sabotage.

Worse than this, the stolen papers reveal that the RDM site is modifying the M114 Launcher to fire Nuclear Missiles (which will double range and increase Hol and Nuclear Power 20 times). RDM and POUDE UNIE (Belgian) are first making 86 of these Nuke Modification Kits, for sale to Pakistan, Thailand, New Zealand, Venezuela and Brazil, as well as confirmed sales to Norway & Denmark.

So it seems the whole world's going Nuclear, as far as long range artillery is concerned. Buy the kit and if you have the M114 (155mm) guns you can join the club. Some countries which have M114s are Spain, Singapore, Phillipines, Sth Korea, Japan, and several Sth American and Middle Eastern Countries.

The name of the group who raided the War Factory is K.R.K.R.M.N., which, loosely translated, means "DONT SHAKE THE GELIGNITE".



All Dutch reports come from FRONTLINE INFO.. Sorry that we couldnt fit in a lot more. Sorry also the German news didnt get through, and lack of space has kept out much other overseas news.. READ BLACK FLAG INSTEAD.....

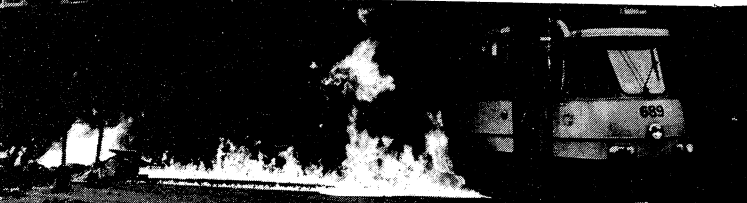

### ANTI-MILITARISTIC ACTION

## War against War

On the first of June the group RAT (Radical Anarchist Terrorgroup) burned down a transit shed on the naval yard in Den Helder (in the north of Holland).

Den Helder is a complete militarised town, where the Dutch marine has got its base. It is also much visited by Nato-squadrons. Also on the terrain is a training camp with real targets and protected by anti-aircraft defence.

The transit shed containing lesson material, books, exercise-books, uniforms and ponies, burned down completely. Despite this the official media kept silent about the action, except for the local newspaper writing that a non-used hut was burned due to a short-circuit. Nothing was said about the damage.

Nobody got arrested during the action and in a statement RAT stated: "This was just one action, but we can ensure the state that more will follow; we will go on to the utmost, and remember: where there is corruption, stink and destruction, there will be RATS!"

## RARA - Sabotage Racism

Rara (Revolutionary Anti-Racist Action) against Apartheid:

In the night of 8 to 9 July a wing of Van Leer Industry by's headquarters burned out. In this headquarter the management of one of 169 Dutch companies involved with South-Africa economy is settled. From the press-statement of the activists:

"This company is responsible for the repression within capitalistic society. We regard attacking imperialistic, economic, political and military institutions as our only perspective."

The pigs estimated the damage on fl.1 million, the company states that the amount of damage is not clear at this moment. Rara is not unknown cause they claimed responsibility for the attack in sept. '85 on the Multinational 'MACRO' which suffered a 20 million damage caused by fire. On the third of september last year, Van Leer Industry bv was also attacked when stones and paint changed the view of the building; -FL. 100.000.- estimated damage.



## Zwarte Kat Saved

Zwarte Kat, Reguliersgracht 116, was squatted on the 30th of March 1981, being an evicted illegal pension. A pension where the owner/speculator Veriinden, put up 40 persons in 6 small rooms to gain more money. This pension was closed down by the council because of fire-danger (2 people were killed in one of his other pensions when a fire broke out!) and lacking facilities.

Veriinden tried all kinds of tricks to remove the squatters and now at last, after 5 years, he seemed to have found an interested buyer. Together they made use of an infamous legal trick, known as the 'Muidenstraat-truc'; the buyer goes to court to demand that the previous owner moves out all persons 'belonging to him', in this case squatters (in the contract of sale it states that the property should be empty before a certain date). The seller not being able to meet this demand, requests police-support and gets it. This dirty trick caused evictions of dozens of squats since 1981, when it was invented by a clever lawyer.

As the squatters and their supporters were preparing hard resistance and this page was being typed, good news reached us: getting scared after continuous intimidations, the buyer withdrew. So Veriinden can start all over again! Ha!

## Throw SHELL Throw well

SPLIT APARTHEID, BURGLARY AT ANGLO-AMERICAN, A SOUTH-AFRICAN MULTI...

Saturday, June 7th, the action group 'split apartheid' broke in at the Dutch place of business of Anglo-American. They took away the complete administration which caused the company to be "greatly put out", as a spokesman later declared. Two people changed into businessmen (as if by magic, well prepared, tracked down the couple that was cleaning the office on Saturday afternoon. Although they didn't trust it completely, the cleaners left the two businessmen behind for their meeting with the manager! "All tracks were covered, after which they left the office leaving all the doors open. After a short time the group came to take everything away. The creative burglary resulted, according to the group, in a lost that shows that this office is dealing with billions. They still have to assort the lost and are going to publish the most important informations.

The press statement: (containing more info about the company) "Anglo-American is a South-African multinational. She owns most of the gold and diamond mines. Her position in the SA-economy is incredible strong. Grown via gold and diamonds she is now represented in all sectors of the economy. Of the 25 biggest S-African companies, 9 are controlled by Anglo (completely or for a large part) (8%) and 54.1% of the shares on the Johannesburg Exchange belong to the company. She is the worlds biggest producer of gold, diamonds (after the USSR) platinum (after the USSR) and vanadium and is amongst the ten biggest for copper, coal, uranium and manganese. Also on industrial products she is very important; the worlds biggest producer of explosives, diamondborers and other specialized mining materials. She has interests in mines in 22 different countries and big minority-shares in some of the biggest mining companies. In 1976 Anglo had strong ties with (and was part of) 73 multinational banking companies and industrial enterprises. For instance, in '80, Anglo was the biggest foreign investor in the USA, bigger than SHELL. Despite all this you won't find A-A corporation on lists of the biggest companies in the world. This is because of her complex structure; all separate members of the Anglo-group have criss-cross shares amongst each other, without having one overall company in which all figure are put together. So there are no figures about the total volume of business, but there are guesses: in 1980 the total property of the group was estimated on 15 billion dollar... This certainly means Anglo-American is amongst the 50 biggest companies in the world.

The heart of Anglo contains 3 companies: Anglo-American Corporation, the Beers in SA and the Minerals and Resources Corporation (minority) on Bermuda. Large parts of shares belong to S-Africans Harry Oppenheimer and family. In the seventies a huge reorganisation of the international investments of the group was started. The centre of this were Minorco on Bermuda and Charter Consolidation in London.



# TIME IS RUNNING OUT

I am writing this against a backdrop of increased illegal direct action in Leeds over the past few months. Most of it has been ALF action, but there have been a few other actions as well. However, these other actions just give the impression of being token gestures, because of their sparse nature. Having been hit (if it is hit at all), a business can sit back safe in the knowledge that it is safe for a few more years...

So while blacks die everyday fighting for their freedom in South Africa, a situation which they find themselves in with no choice, we have the choice of hundreds of targets with their stinking money propping up apartheid. And what happens? - a Barclays gets its cashpoint glued up every now and again. **FUCKING PATHETIC ISN'T IT?**

The Tories are shitting on anyone and everyone who isn't stinking rich, and we are letting them do it. One Tory window gets smashed, yet the many Conservative Clubs are left untouched.

And perhaps worst of all, the whole electoral process passes off smoothly in Leeds, and not one of the polling stations is hit the night before. Our silence is taken as compliance.

I'm not knocking anyone responsible for the few things that have happened - well done, at least someone is having a go! But one action will not change the world, and we must be careful not to get too self-congratulatory. It feels really good to do something and get away with it (and it should be a cause for celebration - don't let anyone tell you otherwise), but this one action should only be a start, and not an excuse to sit back for a few more months. We must both keep up and increase the pressure on our oppressors, using successful hits as confidence and experience builders. Let us show them that no matter how many people they jail, there are more people willing to hit back harder.

If you are capable of doing it, to say that you are too scared to take part in illegal direct action is both very selfish and a COP OUT. What are the consequences we have to face against the consequences faced by a stone-throwing youth in South Africa or a defenceless animal in a vivisection laboratory? I am scared everytime I think of doing something illegal, but I realise that my fear **MUST** be overcome. And if the consequences are massive, should that stop us?

"If a few people take it upon themselves to engage in 'armed struggle', this spells out for us, besides the usual public hostility, police harassment, arrests and defence campaigns, the loss of all our political lessons, gains and strengths." (From an early Class War)

Substitute "armed struggle" for "illegal direct action" in the above quote, and you get an opinion often voiced. Our effectiveness is certainly shown by the amount of attention the authorities give us. We may not be ready for this attention, but we'll have to learn fast because time is running out. To use increased state attention as an argument against illegal direct action is pathetic, and is following in the self-congratulatory, non-effective ghetto of so many dreamers.

If you say you don't agree with illegal direct action, I suppose that's also a good reason not to do it. But ask yourself why you don't agree with it - respect for property? Even that of murdering bastards? That is the state's morality, not mine.

Anger at the shit around us is an honest and genuine reaction. It is wrong to pretend it isn't there. **DIRECT THAT ANGER.**

We reprint the article alongside from the Leeds @ weekly 'No Limits'. Its a good argument and can go further. Its rare for us to criticize @'s (we've enough enemies) but sometimes you gotta be realistic.



To change ourselves within is also vitally important, but it must not take priority over everything else, or else it becomes selfish or inward looking. Direct action must work hand in hand with gradual and personal change. It is no use smashing everything if there is nothing better to replace it with, at the same time, if we don't put up resistance we are not going to be able to set up our own communities/lifestyles etc - the authorities won't let us (Stonehenge being a prime example). We cannot look to a future time and ignore what is happening now.

As regards the problem of seemingly making token gestures, I don't really know what the answer to it is at the moment. More people need to do things more constantly (including me) - if you think you're doing enough, you're probably not. The idea of direct action must be spread to more people. Perhaps different groups/individuals should concentrate on certain types of targets. The ALF unashamedly concentrate on the property of animal abusers, yet see their struggle as only one part of a large whole. No one can claim that their tactics are not effective - their enemies cannot sleep so easily. ALF action in Leeds comes over as more of a concerted campaign than a few token gestures - and good luck to them! They just get on with it, whilst we are bogged down in ideological arguments and theories. So perhaps we can all learn from this and stop the bickering and indecision - for whilst it goes on, people and animals are dying.

Don't pretend to change the world, do it! Believe in your own power to change things. Hit the thing that hurts them the most.

**MAXIMUM DAMAGE NOT TOKEN GESTURES**

Though the @'s in Britain are growing fast more energy goes into making organisations (eg. Class War Fed, DAM, @ Communist Fed, @ passivist Fed etc) than doing any kind of direct action, legal or otherwise. Of course organising is important too, but from our actions in the last 10 years we might as well be a bunch of pacifist middle class wallies! And in bigger demos the @s have often 'bottled out', even sometimes when we vastly outnumbered the pigs. (eg. Homes for All Demo, failed to go thru a single line of cops to get to the squat gig. Or at the 3rd STC, when 30 punks covered with @ slogans were marched right in the copshop by a small no. of filth.)

Of course we've done better than that. Where we should be most effective is in small group actions in our own areas, where just a few activists can make a big impact, in things like squatting, claimants, local campaigns, attacks on sexist, racists, capitalists etc. In the past Crowbar has tried to support and encourage such local direct action as a way of setting an example and directly hurting our oppressors. 'Stop Business as Usual' was a good eg, and it should happen again. But its hard for an occasional squat paper to start calling international Action Days! And the "national" @ groupings, like DAM and CW have been too busy with bitter infighting or publicity stunts to promote local action campaigns.

CW says 'armed struggle' is elitist & tactically wrong. Crowbar has said use only methods & weapons which can easily be copied. 'No Limits' says that even @s seem to be collaborating, by our inaction, as this kip becomes a fascist pig state, openly fostering racist & sexist violence... Ever freer cops, new laws & no protest, cuts race attacks, muggings, Chernobyl, Libyan bombings, Star Wars, Chemical bombs & Cruise missiles.. Are we totally programmed Zombies or what??

# DIRECT YOUR ANGER

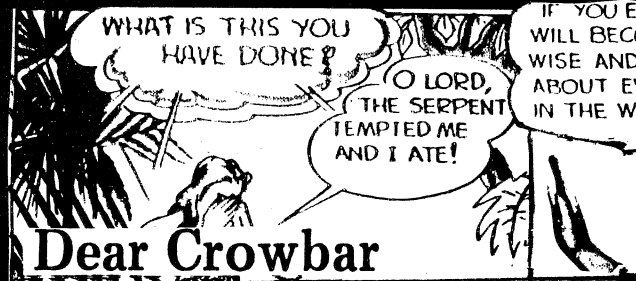

### Dear Crowbar

Of late, it has been noticed that very few Wymyn have been interested in writing for Crowbar. I don't really believe that this is because Crowbar is made by little boys writing down their fantasies of Machismo. I think it's because the wimeyn are happy to keep their myn (if they can tolerate them), snugly off the streets, getting cold feet no doubt, in cosy rooms where they can develop meaningful relationships with other min-who need a drive behind such friendships.

If Wymyn write for Crowbar-not only would they be invading the mens world of squatting but depriving themselves of genuine friendships with their own fryndz. Anarchy is all very well on paper-but what is the point if people cannot communicate on a real and personal level

What is the point if after a night of debauchery you are too hung over or too stoned to do anything outside of your head. Life is real and so are wimeyn-mynt haven't got there yet. In order for them to reach this level of consciousness we may well support them with their moderate fantasies. When they reach reality-then we can begin to challenge them.

Till then, Love and Peace, ♀♀, But only where it counts!

Dear Crowbar,

Here's some stuff you might like to print... (Loot for Africa Rave)... As for @ mags most are good and well written, but they must promote ACTION (like Stop the World). It would be a good idea to get people to write their own articles and send them to as many @ mags as possible. This might break up peoples inertia and laziness, give writers a rest, (what about the typised.ed.) introduce fresh debates and points of view, and give people the incentive to do other things on their own and not rely solely on other peoples brains.....

Solidarity with everyone @@@.

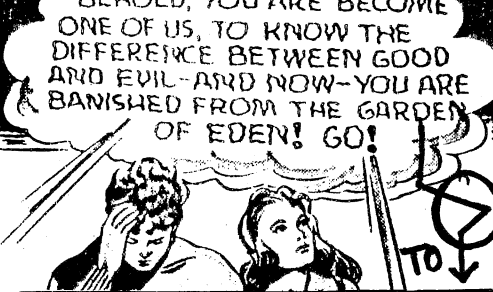

IF YOU EAT IT, YOU WILL BECOME VERY WISE AND KNOW ALL ABOUT EVERYTHING IN THE WORLD-TAKE A BITE!

THEY MADE GARMENTS OUT OF FIG LEAVES

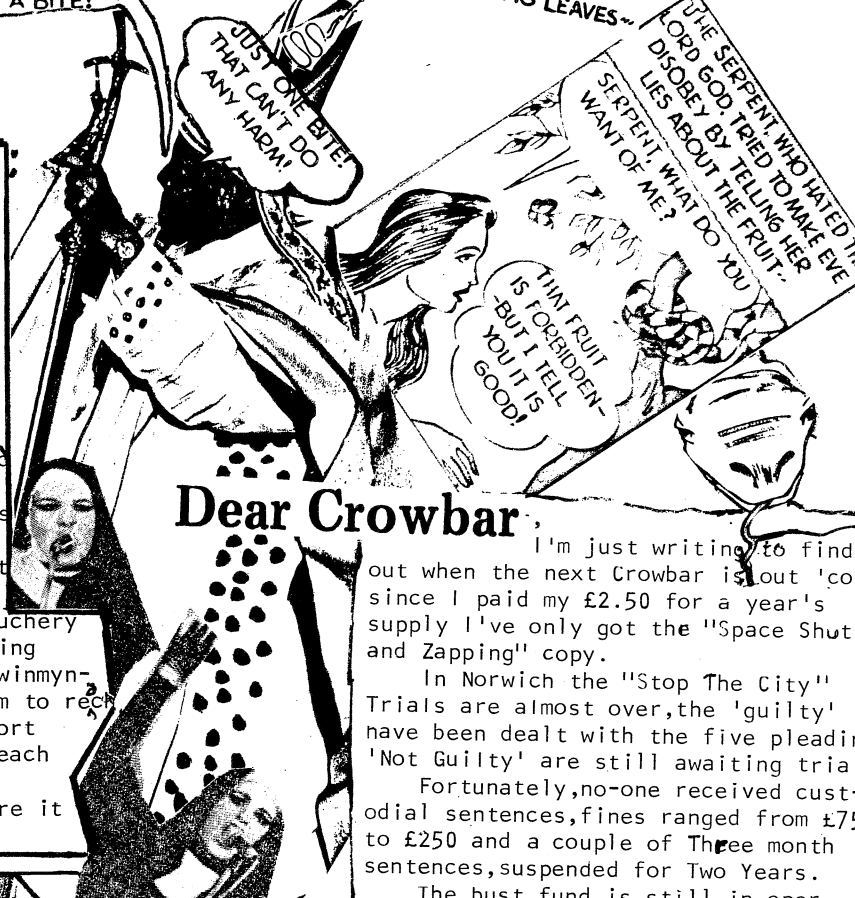

### Dear Crowbar

I'm just writing to find out when the next Crowbar is out since I paid my £2.50 for a year's supply I've only got the "Space Shuttle and Zapping" copy.

In Norwich the "Stop The City" Trials are almost over, the 'guilty' have been dealt with the five pleading 'Not Guilty' are still awaiting trial. Fortunately, no-one received custodial sentences, fines ranged from £75 to £250 and a couple of Three month sentences, suspended for Two Years.

The bust fund is still in operation and money would be gratefully received at : RESIST C/O

The Greenhouse  
48, BEIHEL ST.  
NORWICH  
NORFOLK  
Thanks, MAMMZZK 650/CSK.

HAPPY VALLEY HIGH DAY  
CATERHAM COULSDON..... August 30th.  
On Corporation of the City Of London's Land.  
Without the required permits or orders.  
With all your help, we can defend the stage  
and win the day from the City scumsters!

Dear Crowbar,

Enclosed is a copy of "NYET PRAVDA", the first (I think) Crawley-based @ paper. The reason why it's up to No.7 already is because it's only recently changed from a subversive 6th form mag to a Crawley @ mag, to an entertainments listing mag, to 'Alternative Crawley', to a pavier's mag- the 'Crawley Roundabout' and is now officially underground as the above.

ANYONE in CRAWLEY or surrounding area is asked/begged to buy a copy and to contact us with a view to doing some 'Deeds' in Crawley.

There is no local news in NYET PRAVDA yet as there is nothing to report so we would dearly like to get something going.

For the latest issue just send an (large) SAE to Broomhill House, Rusper Road, Ifield, Crawley RH11 0LQ.

Keep up the good work, if it wasn't for your covers Crowbar would be the best @ mag in the country (Apart from N.P.)

**Logging in to spread the red word**

By JANE WYATT

USERS of a council computer information service were amazed to find it showing support for ... Reading Anarchists.

The activists had tampered with the terminal to get their own message across.

But they claim you don't need to be a whizkid to fool around on Berkshire's mainframe computer.

The culprits declared "Berkshire's computer security is about as watertight as a teabag."

In their alternative newspaper, Red Rag, the anarchists give a detailed guide on how to play games on the Shire Hall terminal.

# BRIXTON SQUATTERS AID

Help And Advice Exchange for Squatters (and Rent Strikers).  
c/o 121 Railton Rd. Tel. 2746655. SUNDAYS 3-5pm



### DEATH OF AN ASIAN

On Nov 7th 85 a gang of white racist youths deliberately ran over 3 women leaving Dartford College, killing Kalbinder Kaur Hayre (Kelly). Despite a strong campaign the cops have refused to charge any of the youths with murder or even to take statements from eye witnesses. One passenger in the van has been charged with manslaughter all right..James Avery, a well known vicious racist. There have been 3 pickets & 2 militant marches thru Dartford but more support is vital. Contact the campaign...Greenwich Action Committee vs, Racist Attacks  
1st floor, 18 Sandy Hill Rd, Woolwich, Lon SE18. Tel 8554343.

## DEFEND UPRISINGS PRISONERS

161 people, mostly black youths, have been charged after defending Broadwater Farm Est. against a mass racist police attack last year- Six are being done for "murdering PC Blakelock. They are Winston Silcott 25, Engin Raghip 19, Mark Braithwaite, 20 and unnamed youths aged 13, 14, and 15. These and the Brixton Uprising defendants are being helped by the Black Peoples Campaign for Justice Tel. 7330916.c/0 Beehive Place, Brixton. The Tottenham 161 are victims of a merciless campaign of terror and lies, raids, ransackings, random arrests, endless interrogations, beatings etc. by a rabid slaving racist police force off the leash and demanding life sentences. These innocent victims need your help now!

### SAVE VIRAJ MENDIS

While Zola Budd, the white Sth African gets Citizenship in 10 days, Viraj Mendis, the anti-racist activist living here 13 years, is being deported to an almost certain death in Sri Lanka.

Viraj is the centre of a campaign against deportations, now running at 60 black people a week under Thatchers racist laws (five times what it was in 76)

Viraj has completed a protest march from Manchester to London, where he joined the Broadwater march and spoke movingly at the Finsbury Anti Racist Festival and a host of public meetings.

Contact c/o his Defence Campaign, Nth Hulme Cntr, Jackson Cres., Hulme, MAN M15. Tel 061 /953870 or

## RACIST PRISONS

Black people are only 3% of the pop., but 23% of all in prison are blacks, who are also more likely to be beaten up by screws and suffer the zombie-drugs treatment, or get murdered like Cartoon Campbell, Paul Worrell, Winston Rose, Harold Roberts, Colin Roach, Michael Martin or Ensif Ryan.

Now its revealed that mental prisons, specially Tooting, are filling up with young blacks, lifted, sectioned, dumped and drugged on a large scale, as a 'punishment' or while the filth make up charges on them. Not only blacks suffer of course, 90% in prison are working class, most inside for "crimes against private property". Nick is just a way holding wealth and power from us by force and threats.

But its black people who are getting the worst of it, and they too who have taken a lead in fighting back and defending their communities.

## SPOT THE NAZI

A large group of fascist skinheads are living at Averell Rd, Finsbury Park, N 15. They're lead by Nicky Crane, a notorious nazi activist. The house is used as a meet for nazis coming from Europe. Its protected by boards + closed circuit TV and is owned by John Hansen.

NEWS YOU WONT FIND IN SEARCHLIGHT

